

TEFEN PRODUCTS CATALOG



TEFEN PRODUCTS

C A T A L O G



PRODUCTS CATALOG

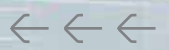

TEFEN Advanced Plastic Solutions



QUALITY ASSURANCE

Quality is an integral part of the development, engineering and production of TEFEN FITTINGS. Starting from raw materials inspection, through ongoing quality assurance during production using Statistical Process Control (SPC) and Total Quality Management (TQM), and finally through testing of the final product before delivery according to ISO 9001:2000 standards.

TIGHT PUSH FITTINGS

- REDUCING UNION CONNECTOR 2
- UNION CONNECTOR 2
- MALE CONNECTOR 2
- FEMALE CONNECTOR 3
- UNION ELBOW 3
- MALE ELBOW 4
- T CONNECTOR 4
- MALE BRANCH T 5
- MALE RUN T 5

BARB BLOCK FITTINGS

- REDUCING CONNECTOR 6
- UNION CONNECTOR 6
- MALE CONNECTOR 7
- FEMALE CONNECTOR 8
- UNION ELBOW 8
- REDUCING UNION ELBOW 8
- MALE ELBOW 9
- FEMALE ELBOW 9
- MALE BRANCH T 10
- FEMALE BRANCH T 10
- MALE RUN T 11
- UNION T 11
- DOUBLE BANJO BODY 12
- SINGLE BANJO BODY 12
- DOUBLE BANJO BODY BOLT 12
- SINGLE BANJO BODY BOLT 13
- NUT FOR UNION CONNECTORS mm. 13
- NUT FOR UNION CONNECTORS inch 13
- FEMALE UNION SWIVEL CONNECTOR 14
- FEMALE ELBOW SWIVEL CONNECTOR 14
- WATER PRE FILTER 14

AGRICULTURE TUBE FITTINGS

- FEMALE SWIVEL HOSE CONNECTOR WITH WASHER 15
- MALE STRAIGHT HOSE CONNECTOR 15
- UNION HOSE CONNECTOR 15
- REDUCING UNION HOSE CONNECTOR 16
- MALE ELBOW HOSE CONNECTOR 16
- REDUCING ELBOW HOSE CONNECTOR 16
- ELBOW HOSE CONNECTOR 17
- MALE BRANCH T HOSE CONNECTOR 17
- T HOSE CONNECTOR 17
- REDUCING T HOSE CONNECTOR 17

INDUSTRIAL PIPE FITTINGS

- FEMALE THREADED STRAIGHT HOSE CONNECTOR 18
- MALE THREADED STRAIGHT HOSE CONNECTOR 19
- SPECIAL PANEL MALE STRAIGHT HOSE CONNECTOR 19
- FLANGE MOUNTING MALE STRAIGHT HOSE CONNECTOR 19
- MALE THREADED ELBOW HOSE CONNECTOR 20
- MALE THREADED ELBOW HOSE CONNECTOR - FLANGE 20
- REDUCING ELBOW HOSE CONNECTOR 21
- ELBOW HOSE CONNECTOR 21
- REDUCING HOSE CONNECTOR 21
- HOSE CONNECTOR 22
- Y HOSE CONNECTOR 22
- UNION T HOSE CONNECTOR 22
- MALE BRANCH T HOSE CONNECTOR 23
- FLANGE BRANCH T HOSE CONNECTOR 23
- REDUCING HOSE CONNECTOR 24

- FEMALE SWIVEL STRAIGHT HOSE CONNECTOR - CONICAL SEAT 24
- FEMALE SWIVEL STRAIGHT HOSE CONNECTOR 24
- FLANGE PIPE ELBOW 25
- SNAP CLIP ACETAL 25

PIPE FITTINGS

- PANEL MOUNTING NUT 26
- PIPE REDUCING NIPPLE 26
- PIPE HEX NIPPLE 26
- PIPE ADAPTOR 27
- PIPE BUSHING 27
- FEMALE PIPE COUPLING 28
- THREADED ELBOW 28
- THREADED REDUCING ELBOW 28
- HEX THREADED PLUG 28
- HEX THREADED FLANGE PLUG 29
- PIPE CAP 29
- PIPE REDUCING COUPLING 29
- PIPE T 30
- PIPE REDUCING BRANCH T 30
- PIPE REDUCING RUN T 30

GENERAL INDUSTRIAL ACCESSORIES

- QUICK RELEASE SOCKET 31
- PLUG - EXTERNAL THREAD 31
- PLUG - INTERNAL THREAD 31
- PLUG - HOSE CONNECTOR 32
- VALVE 1/4" 32
- SILENCER WITH RESTRICTOR VALVE FOR PNEUMATIC VALVES 32
- VALVE RELEASE / DRAIN VALVE 32

TUBES

- LDPE CONTROL TUBES 33
- LDPE TUBES 33
- HDPE TUBES 34
- PLASTICIZED PVC TUBES 34

AIR BLOW GUNS

- AIR BLOW GUN 35
- AIR BLOW GUN MARK II 35
- AIR BLOW GUN MARK III 35
- MINI AIR BLOW GUN 36
- SPRAY GUN 36
- FINE SPRAY 36
- 8 mm NYLON RETRACTABLE COIL 36
- SHORT SPRAY GUN 36

SPRAYING & FOGGING NOZZLES

- FAN SPRAY NOZZLES 37
- CONICAL SPRAY NOZZLE 37
- CONICAL SPRAY NOZZLE 1/8" NPT 37
- NON DROP CONICAL SPRAY NOZZLES 1/8" NPT 37
- CONICAL SPRAY NOZZLE 1/8" NPT WITH FILTER 38
- ADJUSTABLE NOZZLE 38
- NOZZLE FILTERS 38
- NON DROP NOZZLE FILTERS 38
- NUT 11/16" FOR NOZZLE 39
- 1/4" FEMALE STRAIGHT NOZZLE HOLDER 39
- 1/4" MALE STRAIGHT NOZZLE HOLDER 39
- 1/4" FEMALE 135° NOZZLE HOLDER 39
- PUSH-IN FITTING ADAPTOR FOR 1/8" NOZZLES 40
- MISTING UNIT MARK 1 40
- FINGER FILTER 40

TIGHT PUSH FITTINGS

Material: Acetal copolymer resin.

Colour: Black.

Size colour code: Red support ring = mm
Yellow support ring = inch

 Working pressure: Up to 14 BAR (200 psi) at 20°C.

 Temperature: -20°C + 90°C (subject to application).

Assembly: The tube is pushed into the connector and secured by a nut tightening the outer surface of the tube and sealed with a grip ring and NBR "O" ring.

Advantages: Quick assembly without dismantling the fitting. Allowing uninterrupted passage of water or air. Uses: Hydraulic and pneumatic systems mostly indoor applications.

→ REDUCING UNION CONNECTOR



CAT. NO.	Tube O.D	Tube O.D	SW mm	SW1 mm	SW2 mm
22005604032	1/4"	3/16"	15	15	14
22005605032	5/16"	3/16"	16	17	14
22005605042	5/16"	1/4"	16	17	15
22005606042	3/8"	1/4"	19	19	15
22005606052	3/8"	5/16"	19	19	16
22005608052	1/2"	5/16"	22	22	16
22005608062	1/2"	3/8"	22	22	19
22005646442	6 mm	4 mm	15	15	14
22005648442	8 mm	4 mm	16	17	14
22005648462	8 mm	6 mm	16	17	15
22005650462	10 mm	6 mm	19	19	15
22005650482	10 mm	8 mm	19	19	16
22005652482	12 mm	8 mm	22	22	16
22005652502	12 mm	10 mm	22	22	19

→ UNION CONNECTOR

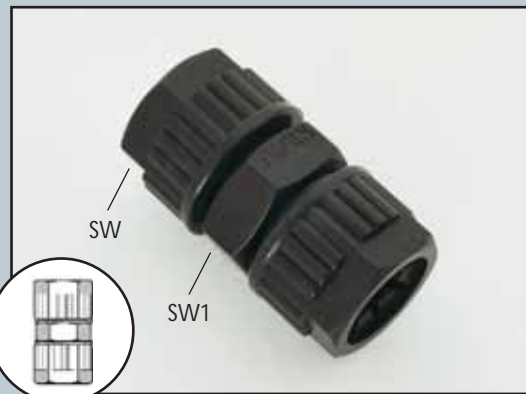

CAT. NO.	Tube O.D	SW mm	SW1 mm
22006203002	3/16"	14	14
22006204002	1/4"	15	15
22006205002	5/16"	16	16
22006206002	3/8"	19	19
22006208002	1/2"	22	22
22006244002	4 mm	14	14
22006246002	6 mm	15	15
22006248002	8 mm	16	16
22006250002	10 mm	19	19
22006252002	12 mm	22	22

→ MALE CONNECTOR



CAT. NO.	Tube O.D	Thread BSPT	SW mm	SW1 mm
22006803022	3/16"	1/8"	14	14
22006803042	3/16"	1/4"	14	14
22006804022	1/4"	1/8"	15	14
22006804042	1/4"	1/4"	15	15
22006805022	5/16"	1/8"	16	15
22006805042	5/16"	1/4"	16	17
22006806042	3/8"	1/4"	19	17
22006806062	3/8"	3/8"	19	19
22006808062	1/2"	3/8"	22	22
22006808082	1/2"	1/2"	22	22
22006844022	4 mm	1/8"	14	14
22006844042	4 mm	1/4"	14	14
22006846022	6 mm	1/8"	15	14
22006846042	6 mm	1/4"	15	15
22006848022	8 mm	1/8"	16	15
22006848042	8 mm	1/4"	16	17
22006850042	10 mm	1/4"	19	17
22006850062	10 mm	3/8"	19	19
22006852062	12 mm	3/8"	22	22
22006852082	12 mm	1/2"	22	22

→ OD-Outer diameter → SW-Standard Wrench
→ ID-Inner diameter → R-Radius

→ FEMALE CONNECTOR



CAT. NO.	Tube O.D	Thread BSPT	SW mm	SW1 mm	Color
22006603022	3/16"	1/8"	14	15	Black
22006603042	3/16"	1/4"	14	17.5	Black
22006604022	1/4"	1/8"	15	15.5	Black
22006604042	1/4"	1/4"	15	17.5	Black
22006605022	5/16"	1/8"	16	17	Black
22006605042	5/16"	1/4"	16	17	Black
22006605062	5/16"	3/8"	16	17	Black
22006605082	5/16"	1/2"	16	17	Black
22006606022	3/8"	1/8"	19	19	Black
22006606042	3/8"	1/4"	19	19	Black
22006606062	3/8"	3/8"	19	19	Black
22006606082	3/8"	1/2"	19	19	Black
22006608062	1/2"	3/8"	22	22	Black
22006608082	1/2"	1/2"	22	24	Black
22006644022	4 mm	1/8"	14	15	Black
22006644042	4 mm	1/4"	14	17.5	Black
22006646022	6 mm	1/8"	15	15	Black
22006646042	6 mm	1/4"	15	17	Black
22006648022	8 mm	1/8"	16	17	Black
22006648042	8 mm	1/4"	16	17	Black
22006648062	8 mm	3/8"	16	17	Black
22006648082	8 mm	1/2"	16	17	Black
22006650022	10 mm	1/8"	19	19	Black
22006650042	10 mm	1/4"	19	19	Black
22006650041	10 mm	1/4"	19	19	Black
22006650047	10 mm	1/4"	19	19	Black
22006650062	10 mm	3/8"	19	19.5	Black
22006650082	10 mm	1/2"	19	19.5	Black
22006652062	12 mm	3/8"	22	22.5	Black
22006652082	12 mm	1/2"	22	24	Black

CAT. NO.	Tube O.D	Thread NPT	SW mm	SW1 mm	Color
22286602023	5/32"	1/8"	14	15	Grey
22286602043	5/32"	1/4"	14	17.5	Grey
22286603023	3/16"	1/8"	14	15	Grey
22286603043	3/16"	1/4"	14	17.5	Grey
22286604023	1/4"	1/8"	15	15.5	Grey
22286604043	1/4"	1/4"	15	17.5	Grey
22286605023	5/16"	1/8"	16	17	Grey
22286605043	5/16"	1/4"	16	17	Grey
22286605063	5/16"	3/8"	16	22	Grey
22286605083	5/16"	1/2"	16	24	Grey
22286606023	3/8"	1/8"	19	19	Grey
22286606043	3/8"	1/4"	19	19	Grey
22286606063	3/8"	3/8"	19	19	Grey
22286606083	3/8"	1/2"	19	19	Grey
22286608063	1/2"	3/8"	22	22.5	Grey
22286608083	1/2"	1/2"	22	24	Grey

→ UNION ELBOW



CAT. NO.	Tube O.D	SW mm	SW1 mm
22006503002	3/16"	14	8.5
22006504002	1/4"	15	10
22006505002	5/16"	16	12
22006506002	3/8"	19	14
22006508002	1/2"	22	17
22006544002	4 mm	14	8
22006546002	6 mm	15	10
22006548002	8 mm	16	12
22006550002	10 mm	19	15
22006552002	12 mm	22	17

TIGHT PUSH FITTINGS ←

→ OD-Outer diameter → SW-Standard Wrench
→ ID-Inner diameter → R-Radius

→ M A L E E L B O W



CAT. NO.	Tube O.D	Thread BSPT	SW mm	SW1 mm
22006903022	3/16"	1/8"	14	8
22006903042	3/16"	1/4"	14	8
22006904022	1/4"	1/8"	15	10
22006904042	1/4"	1/4"	15	10
22006905022	5/16"	1/8"	16	12
22006905042	5/16"	1/4"	16	12
22006906042	3/8"	1/4"	19	15
22006906062	3/8"	3/8"	19	15
22006908062	1/2"	3/8"	22	17
22006908082	1/2"	1/2"	22	17
22006944022	4 mm	1/8"	14	8
22006944042	4 mm	1/4"	14	8
22006946022	6 mm	1/8"	15	10
22006946042	6 mm	1/4"	15	10
22006948022	8 mm	1/8"	16	12
22006948042	8 mm	1/4"	16	12
22006950042	10 mm	1/4"	19	15
22006950062	10 mm	3/8"	19	15
22006952062	12 mm	3/8"	22	17
22006952082	12 mm	1/2"	22	17

→ T C O N N E C T O R



CAT. NO.	Tube O.D	SW mm	SW1 mm
22006403032	3/16"	14	8
22006404042	1/4"	15	10
22006405052	5/16"	16	12
22006406062	3/8"	19	15
22006408082	1/2"	22	17
22006444442	4 mm	14	8
22006446462	6 mm	15	10
22006448482	8 mm	16	12
22006450502	10 mm	19	15
22006452522	12 mm	22	17



→ OD-Outer diameter → SW-Standard Wrench
 → ID-Inner diameter → R-Radius



→ M A L E B R A N C H T



CAT. NO.	Tube O.D	Thread BSPT	SW mm	SW1 mm
22007103022	3/16"	1/8"	14	8
22007103042	3/16"	1/4"	14	8
22007104022	1/4"	1/8"	15	10
22007104042	1/4"	1/4"	15	10
22007105022	5/16"	1/8"	16	12
22007105042	5/16"	1/4"	16	12
22007106042	3/8"	1/4"	19	15
22007106062	3/8"	3/8"	19	15
22007108062	1/2"	3/8"	22	17
22007108082	1/2"	1/2"	22	17
22007144022	4 mm	1/8"	14	8
22007144042	4 mm	1/4"	14	8
22007146022	6 mm	1/8"	15	10
22007146042	6 mm	1/4"	15	10
22007148022	8 mm	1/8"	16	12
22007148042	8 mm	1/4"	16	12
22007150042	10 mm	1/4"	19	15
22007150062	10 mm	3/8"	19	15
22007152062	12 mm	3/8"	22	17
22007152082	12 mm	1/2"	22	17

→ M A L E R U N T





CAT. NO.	Tube O.D	Thread BSPT	SW mm	SW1 mm
22007203022	3/16"	1/8"	14	8
22007203042	3/16"	1/4"	14	8
22007204022	1/4"	1/8"	15	10
22007204042	1/4"	1/4"	15	10
22007205022	5/16"	1/8"	16	12
22007205042	5/16"	1/4"	16	12
22007206042	3/8"	1/4"	19	15
22007206062	3/8"	3/8"	19	15
22007208062	1/2"	3/8"	22	17
22007208082	1/2"	1/2"	22	17
22007244022	4 mm	1/8"	14	8
22007244042	4 mm	1/4"	14	8
22007246022	6 mm	1/8"	15	10
22007246042	6 mm	1/4"	15	10
22007248022	8 mm	1/8"	16	12
22007248042	8 mm	1/4"	16	12
22007250042	10 mm	1/4"	19	15
22007250062	10 mm	3/8"	19	15
22007252062	12 mm	3/8"	22	17
22007252082	12 mm	1/2"	22	17



→ OD-Outer diameter → SW-Standard Wrench
→ ID-Inner diameter → R-Radius

BARB BLOCK FITTINGS

- Material: Fiberglass reinforced polypropylene.
- Colour: Blue.
-  Working pressure: Up to 14 BAR (200 psi) at 20°C.
-  Temperature: 4°C + 90°C (subject to application).

Assembly: The nut is threaded onto the tube, which is dressed onto the barb. The nut is tightened on the inner and outer surfaces of the tube, insuring tight fitting on various pipe tolerances.

Advantages: Quick assembly.
 Good resistance to chemicals and fertilizers.
 Excellent for indoor, outdoor and field applications.
 Uses: Hydraulic systems.

→ **REDUCING CONNECTOR**







CAT. NO.	Tube O.D	Tube O.D	SW mm	SW1 mm	SW2 mm	Color
22045648468	8 mm	6 mm	14	14	14	
22045605048	5/16"	1/4"	14	14	14	
22245605043	5/16"	1/4"	14	14	14	

WRAS
APPROVED PRODUCT

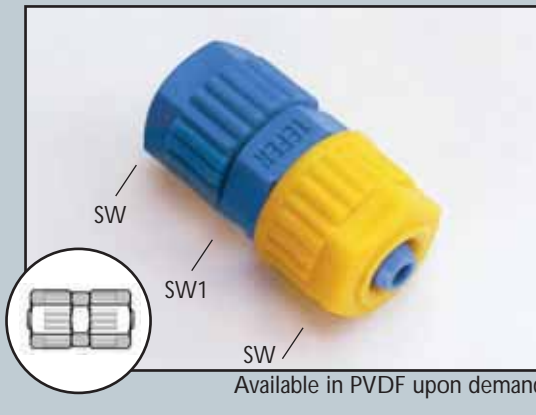
Available in PVDF upon demand

→ **UNION CONNECTOR**



CAT. NO.	Tube O.D	SW mm	SW1 mm	Color
22046246008	6 mm	14	14	
22046248008	8 mm	14	14	
22046252008	12 mm	19	19	
CAT. NO.	Tube O.D	SW mm	SW1 mm	Color
22046204008	1/4"	14	14	
22046205008	5/16"	14	14	
22046208008	1/2"	19	19	
CAT. NO.	Tube O.D	SW mm	SW1 mm	Color
22246204003	1/4"	14	14	
22246205003	5/16"	14	14	
22246208003	1/2"	19	19	



WRAS
APPROVED PRODUCT

Available in PVDF upon demand

→ OD-Outer diameter → SW-Standard Wrench
 → ID-Inner diameter → R-Radius

WRAS Certification is only for blue barb block fittings

THE LAST DIGIT OF THE CAT. NO. MARKS THE COLOR:

-  8 BSPT with mm tube size
-  8 BSPT with inch tube size
-  3 NPT with inch tube size

→ MALE CONNECTOR

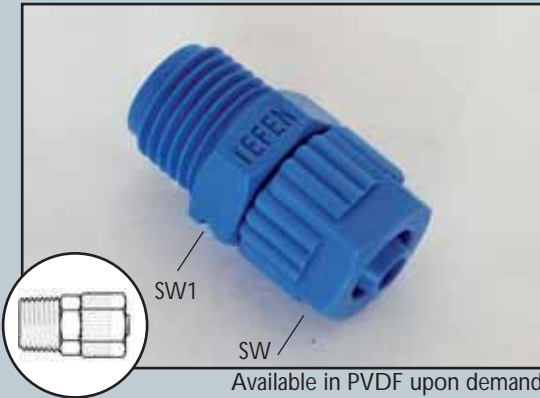

CAT. NO.	Tube O.D	Thread BSPT	SW mm	SW1 mm	Color
22046846028	6 mm	1/8"	14	13	
22046846048	6 mm	1/4"	14	15	
22046846068	6 mm	3/8"	14	18	
22046846088	6 mm	1/2"	14	22	
22046846128	6 mm	3/4"	14	27	
22046848028	8 mm	1/8"	14	13	
22046848048	8 mm	1/4"	14	15	
22046848068	8 mm	3/8"	14	18	
22046848088	8 mm	1/2"	14	22	
22046848128	8 mm	3/4"	14	27	
22046850048	10 mm	1/4"	17	17	
22046850068	10 mm	3/8"	17	17	
22046850088	10 mm	1/2"	17	22	
22046850128	10 mm	3/4"	17	27	
22046852048	12 mm	1/4"	19	14	
22046852068	12 mm	3/8"	19	18	
22046852088	12 mm	1/2"	19	22	
22046852128	12 mm	3/4"	19	27	
22046848022	8 mm	1/8"	14	13	

CAT. NO.	Tube O.D	Thread BSPT	SW mm	SW1 mm	Color
22046804028	1/4"	1/8"	14	13	
22046804048	1/4"	1/4"	14	15	
22046804068	1/4"	3/8"	14	18	
22046804088	1/4"	1/2"	14	22	
22046804128	1/4"	3/4"	14	27	
22046805028	5/16"	1/8"	14	13	
22046805048	5/16"	1/4"	14	15	
22046805068	5/16"	3/8"	14	18	
22046806048	3/8"	1/4"	17	17	
22046806068	3/8"	3/8"	17	17	
22046806088	3/8"	1/2"	17	22	
22046806128	3/8"	3/4"	17	27	
22046808048	1/2"	1/4"	19	14	
22046808068	1/2"	3/8"	19	18	
22046808088	1/2"	1/2"	19	22	
22046808128	1/2"	3/4"	19	27	

CAT. NO.	Tube O.D	Thread NPT	SW mm	SW1 mm	Color
22246804023	1/4"	1/8"	14	13	
22246804043	1/4"	1/4"	14	15	
22246804083	1/4"	1/2"	14	22	
22246804123	1/4"	3/4"	14	27	
22246805023	5/16"	1/8"	14	13	
22246805043	5/16"	1/4"	14	15	
22246805063	5/16"	3/8"	14	18	
22246805083	5/16"	1/2"	14	22	
22246805123	5/16"	3/4"	14	27	
22246806043	3/8"	1/4"	17	15	
22246806063	3/8"	3/8"	17	18	
22246806083	3/8"	1/2"	17	22	
22246806123	3/8"	3/4"	17	27	
22246808043	1/2"	1/4"	19	15	
22246808063	1/2"	3/8"	19	18	
22246808083	1/2"	1/2"	19	22	
22246808123	1/2"	3/4"	19	18	

WRAS
APPROVED
PRODUCT

→ OD-Outer diameter → SW-Standard Wrench
→ ID-Inner diameter → R-Radius

→ FEMALE CONNECTOR

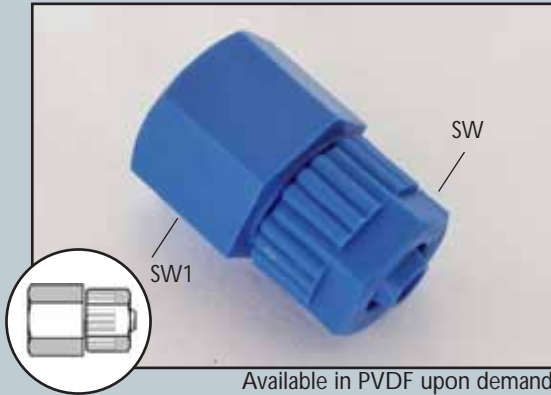

Available in PVDF upon demand



CAT. NO.	Tube O.D	Thread BSPT	Thread mm	SW mm	SW1 mm	Color
22046646028	6 mm	1/8"		14	14	
22046646048	6 mm	1/4"		14	17	
22046648028	8 mm	1/8"		14	14	
22046648048	8 mm	1/4"		14	17	
22046648548	8 mm		M14x1.5	14	17	
22046648068	8 mm	3/8"		14	22	
22046648088	8 mm	1/2"		14	26	
22046650048	10 mm	1/4"		17	17	
22046650068	10 mm	3/8"		17	22	
22046650088	10 mm	1/2"		17	26	

CAT. NO.	Tube O.D	Thread BSPT	SW mm	SW1 mm	Color
22046604028	1/4"	1/8"	14	14	
22046604048	1/4"	1/4"	14	17	
22046605028	5/16"	1/8"	14	14	
22046605048	5/16"	1/4"	14	17	
22046605068	5/16"	3/8"	14	22	
22046605088	5/16"	1/2"	14	26	
22046606048	3/8"	1/4"	17	17	
22046606068	3/8"	3/8"	17	22	
22046606088	3/8"	1/2"	17	26	

CAT. NO.	Tube O.D	Thread NPT	SW mm	SW1 mm	Color
22246604023	1/4"	1/8"	14	14	
22246605023	5/16"	1/8"	14	14	
22246605043	5/16"	1/4"	14	17	
22246605063	5/16"	3/8"	14	22	
22246605083	5/16"	1/2"	14	26	
22246606043	3/8"	1/4"	17	17	
22246606063	3/8"	3/8"	17	22	
22246606083	3/8"	1/2"	17	26	

→ UNION ELBOW

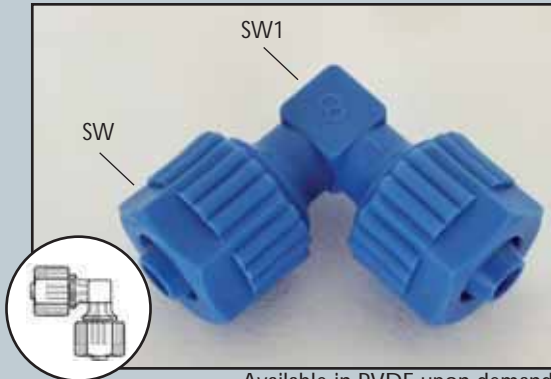

Available in PVDF upon demand



CAT. NO.	Tube O.D	SW mm	SW1 mm	Color
22046546008	6 mm	14	8	
22046548008	8 mm	14	8	
22046552008	12 mm	19	15	

CAT. NO.	Tube O.D	SW mm	SW1 mm	Color
22046504008	1/4"	14	8	
22046505008	5/16"	14	8	
22046508008	1/2"	19	15	
22046508002	1/2"	19	15	

CAT. NO.	Tube O.D	SW mm	SW1 mm	Color
22246504003	1/4"	14	8	
22246505003	5/16"	14	8	
22246508003	1/2"	19	15	

→ REDUCING UNION ELBOW

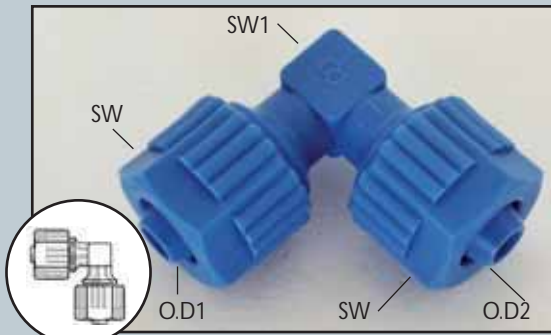

Available in PVDF upon demand



CAT. NO.	Tube O.D1	Tube O.D2	SW mm	SW1 mm	Color
22045748468	8 mm	6 mm	14	8	

THE LAST DIGIT OF THE CAT. NO. MARKS THE COLOR:



Certification is only for blue barb block fittings

8

BSPT with mm tube size

BSPT with inch tube size

NPT with inch tube size

→ MALE ELBOW

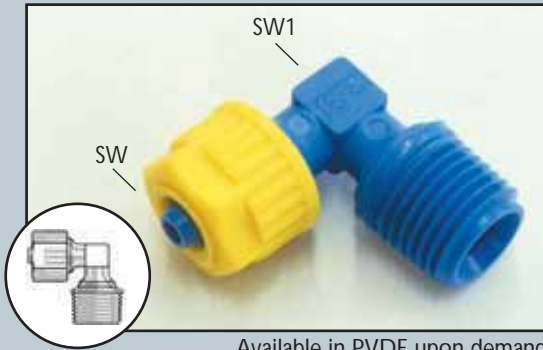

Available in PVDF upon demand

CAT. NO.	Tube O.D.	Thread BSPT	SW mm	SW1 mm	Color
22046946028	6 mm	1/8"	14	8	
22046946048	6 mm	1/4"	14	8	
22046948028	8 mm	1/8"	14	8	
22046948048	8 mm	1/4"	14	8	
22046948068	8 mm	3/8"	14	8	
22046952048	12 mm	1/4"	19	15	
22046952068	12 mm	3/8"	19	15	
22046952088	12 mm	1/2"	19	15	
22046946022	6 mm	1/8"	14	8	
22046948022	8 mm	1/8"	14	8	

CAT. NO.	Tube O.D.	Thread BSPT	SW mm	SW1 mm	Color
22046904028	1/4"	1/8"	14	8	
22046904048	1/4"	1/4"	14	8	
22046905028	5/16"	1/8"	14	8	
22046905048	5/16"	1/4"	14	8	
22046905068	5/16"	3/8"	14	8	
22046908048	1/2"	1/4"	19	15	
22046908068	1/2"	3/8"	19	15	
22046908088	1/2"	1/2"	19	15	
22046908082	1/2"	1/2"	19	15	

CAT. NO.	Tube O.D.	Thread NPT	SW mm	SW1 mm	Color
22246904023	1/4"	1/8"	14	8	
22246904043	1/4"	1/4"	14	8	
22246905023	5/16"	1/8"	14	8	
22246905043	5/16"	1/4"	14	8	



→ FEMALE ELBOW



Available in PVDF upon demand

CAT. NO.	Tube O.D.	Thread BSPT	SW mm	SW1 mm	Color
22046046028	6 mm	1/8"	14	8	
22046046048	6 mm	1/4"	14	8	
22046048048	8 mm	1/4"	14	8	
22046046022	6 mm	1/8"	14	8	
22046046042	6 mm	1/4"	14	8	
22046048042	8 mm	1/4"	14	8	



Certification is only for blue barb block fittings

THE LAST DIGIT OF THE CAT. NO. MARKS THE COLOR:



BSPT with mm tube size



BSPT with inch tube size



NPT with inch tube size

→ OD-Outer diameter → SW-Standard Wrench
→ ID-Inner diameter → R-Radius

→ MALE BRANCH T

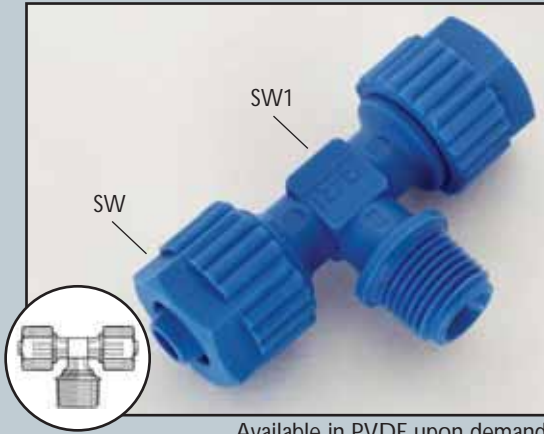

Available in PVDF upon demand

CAT. NO.	Tube O.D.	Thread BSPT	SW mm	SW1 mm	Color	
22047146028	6 mm	1/8"	14	8		
22047146048	6 mm	1/4"	14	8		
22047148028	8 mm	1/8"	14	8		
22047148048	8 mm	1/4"	14	8		
22047148068	8 mm	3/8"	14	8		
22047152048	12 mm	1/4"	19	15		
22047152068	12 mm	3/8"	19	15		
22047152088	12 mm	1/2"	19	15		
22047146042	6 mm	1/4"	14	8		
22047148022	8 mm	1/8"	14	8		
22047148042	8 mm	1/4"	14	8		

CAT. NO.	Tube O.D.	Thread BSPT	SW mm	SW1 mm	Color
22047104028	1/4"	1/8"	14	8	
22047104048	1/4"	1/4"	14	8	
22047105028	5/16"	1/8"	14	8	
22047105048	5/16"	1/4"	14	8	
22047105068	5/16"	3/8"	14	8	
22047108048	1/2"	1/4"	19	15	
22047108068	1/2"	3/8"	19	15	

CAT. NO.	Tube O.D.	Thread NPT	SW mm	SW1 mm	Color
22247108063	1/2"	3/8"	19	15	
22247108083	1/2"	1/2"	19	15	
22247104023	1/4"	1/8"	14	8	
22247104043	1/4"	1/4"	14	8	
22247105023	5/16"	1/8"	14	8	
22247105043	5/16"	1/4"	14	8	



→ FEMALE BRANCH T



Available in PVDF upon demand

CAT. NO.	Tube O.D.	Thread BSPT	SW mm	SW1 mm	Color
22047346028	6 mm	1/8"	14	8	
22047348048	8 mm	1/4"	14	8	
22047304028	1/4"	1/8"	14	8	
22047305048	5/16"	1/4"	14	8	



Certification is only for blue barb block fittings

THE LAST DIGIT OF THE CAT. NO. MARKS THE COLOR:

8 BSPT with mm tube size

8 BSPT with inch tube size

3 NPT with inch tube size

→ MALE RUN T

Available in PVDF upon demand

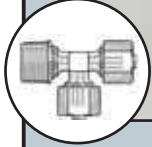
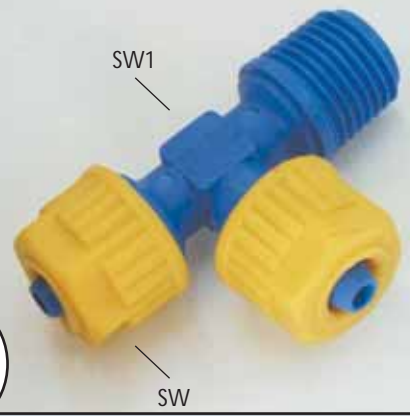

CAT. NO.	Tube	Thread BSPT	SW mm	SW1 mm	Color
22047246028	6 mm	1/8"	14	8	
22047246048	6 mm	1/4"	14	8	
22047248028	8 mm	1/8"	14	8	
22047248048	8 mm	1/4"	14	8	
22047248068	8 mm	3/8"	14	8	
22047252048	12 mm	1/4"	19	15	
22047252068	12 mm	3/8"	19	15	
22047252088	12 mm	1/2"	19	15	

CAT. NO.	Tube	Thread BSPT	SW mm	SW1 mm	Color
22047204028	1/4"	1/8"	14	8	
22047204048	1/4"	1/4"	14	8	
22047205028	5/16"	1/8"	14	8	
22047205048	5/16"	1/4"	14	8	
22047205068	5/16"	3/8"	14	8	
22047208048	1/2"	1/4"	19	15	
22047208068	1/2"	3/8"	19	15	
22047208088	1/2"	1/2"	19	15	

CAT. NO.	Tube	Thread NPT	SW mm	SW1 mm	Color
22247204023	1/4"	1/8"	14	8	
22247204043	1/4"	1/4"	14	8	
22247205023	5/16"	1/8"	14	8	
22247205043	5/16"	1/4"	14	8	
22247205063	5/16"	3/8"	14	8	
22247208023	1/2"	1/8"	14	8	



→ UNION T

Available in PVDF upon demand

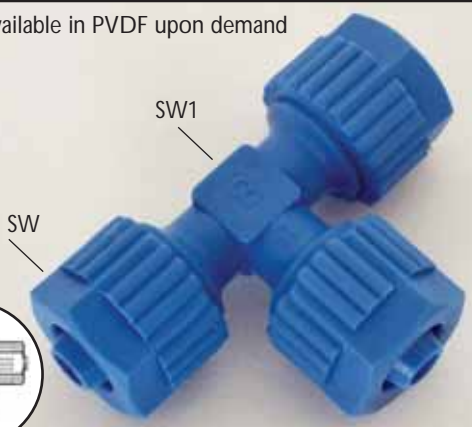

CAT. NO.	Tube O.D	SW mm	SW1 mm	Color
22046446468	6 mm	14	8	
22046448488	8 mm	14	8	
22046452528	12 mm	19	14	

CAT. NO.	Tube O.D	SW mm	SW1 mm	Color
22046404041	1/4"	14	8	
22046404048	1/4"	14	8	
22046405058	5/16"	14	8	
22046408088	1/2"	19	14	
22046404042	1/4"	14	8	
22046408082	1/2"	19	14	

CAT. NO.	Tube O.D	SW mm	SW1 mm	Color
22246404043	1/4"	14	8	
22246405053	5/16"	14	8	
22246408083	1/2"	19	14	

Available in PVDF upon demand

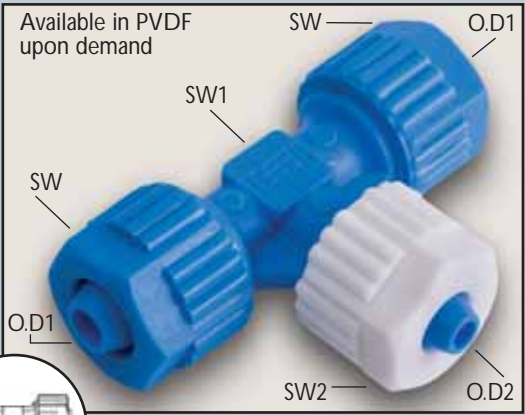

CAT. NO.	Tube O.D1	Tube O.D2	SW mm	SW2 mm	SW1 mm	Color
22045846488	6 mm	8 mm	14	14	8	
22045848468	8 mm	6 mm	14	14	8	



Certification is only for blue barb block fittings

THE LAST DIGIT OF THE CAT. NO. MARKS THE COLOR:

- BSPT with mm tube size
- BSPT with inch tube size
- NPT with inch tube size

→ OD-Outer diameter → SW-Standard Wrench
→ ID-Inner diameter → R-Radius

→ OD-Outer diameter → SW-Standard Wrench
 → ID-Inner diameter → R-Radius

→ DOUBLE BANJO BODY

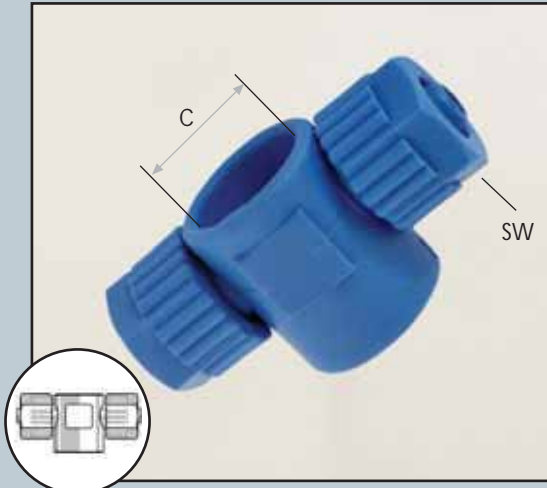

CAT. NO.	Tube O.D	Tube O.D	C Bore	SW mm	Color
22044946028	6 mm	6 mm	1/8"	14	
22044946048	6 mm	6 mm	1/4"	14	
22044986028	8 mm	6 mm	1/8"	14	
22044986048	8 mm	6 mm	1/4"	14	
22044988028	8 mm	8 mm	1/8"	14	
22044988048	8 mm	8 mm	1/4"	14	

CAT. NO.	Tube O.D	Tube O.D	C Bore	SW mm	Color
22044904028	1/4"	1/4"	1/8"	14	
22044904048	1/4"	1/4"	1/4"	14	
22044954028	5/16"	1/4"	1/8"	14	
22044954048	5/16"	1/4"	1/4"	14	
22044905028	5/16"	5/16"	1/8"	14	
22044905048	5/16"	5/16"	1/4"	14	

WRAS
APPROVED PRODUCT

→ SINGLE BANJO BODY

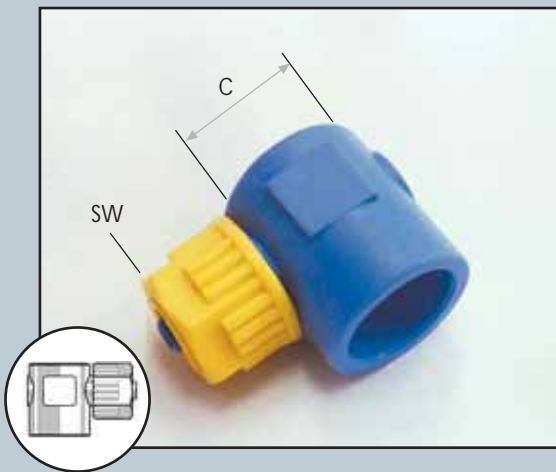

CAT. NO.	Tube O.D	SW mm	C-Bore	Color
22044846028	6 mm	14	1/8"	
22044846048	6 mm	14	1/4"	
22044848028	8 mm	14	1/8"	
22044848048	8 mm	14	1/4"	

CAT. NO.	Tube O.D	SW mm	C-Bore	Color
22044804028	1/4"	14	1/8"	
22044804048	1/4"	14	1/4"	
22044805028	5/16"	14	1/8"	
22044805048	5/16"	14	1/4"	

WRAS
APPROVED PRODUCT

→ DOUBLE BANJO BODY BOLT

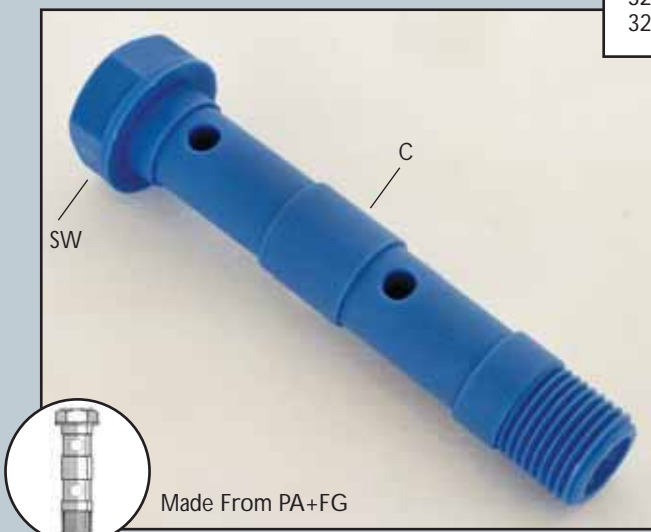

CAT. NO.	SW mm	C-Bore	Thread BSP
32045102028	16 mm	1/8"	1/8"
32045104048	16 mm	1/4"	1/4"

WRAS
APPROVED PRODUCT

→ SINGLE BANJO BODY BOLT

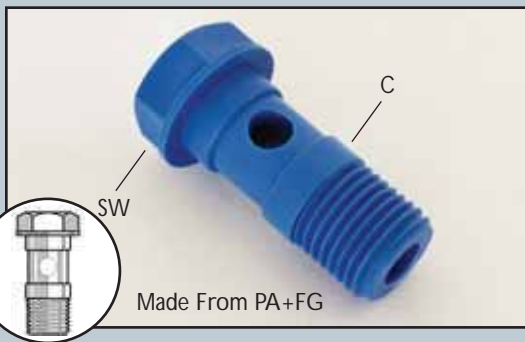

CAT. NO.	SW mm	C-Bore	Thread BSP
32045002028	16 mm	1/8"	1/8"
32045004048	16 mm	1/4"	1/4"



→ NUT FOR UNION CONNECTORS

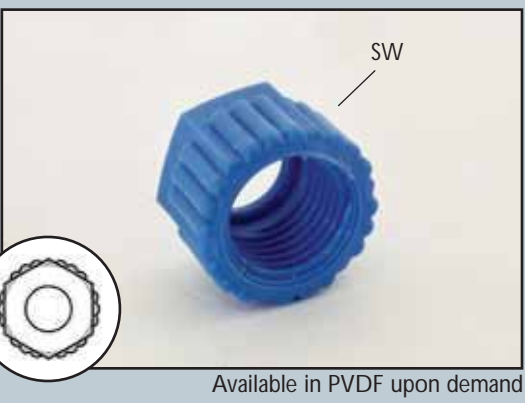

CAT. NO.	Colour	Hose O.D	SW
32046104001	white	1/4"	14
32046104002	black	1/4"	14
32046104009	yellow	1/4"	14
32046108009	yellow long	1/2"	19
32046108012	black short	1/2"	19
32046108019	yellow short	1/2"	19
32046146001	white	6 mm	14
32046146006	red	6 mm	14
32046146008	blue	6 mm	14
32046146009	yellow	6 mm	14
32046148001	white	8 mm	14
32046148006	red	8 mm	14
32046148008	blue	8 mm	14
32046148009	yellow	8 mm	14
32046150008	blue	10 mm	17
32046150009	yellow	10 mm	17
32046150002	black	10 mm	17
32046152006	red long	12 mm	19
32046152008	blue long	12 mm	19
32046152016	red short	12 mm	19
32046152002	black long	12 mm	19



→ NUT FOR UNION CONNECTOR inch



CAT. NO.	Hose O.D	SW	Colour
32246104003	1/4"	14	
32246105003	5/16"	14	
32246106003	3/8"	17	
32246108003	1/2"	19	

→ OD-Outer diameter → SW-Standard Wrench
→ ID-Inner diameter → R-Radius

→ OD-Outer diameter → SW-Standard Wrench
 → ID-Inner diameter → R-Radius

→ FEMALE UNION SWIVEL CONNECTOR

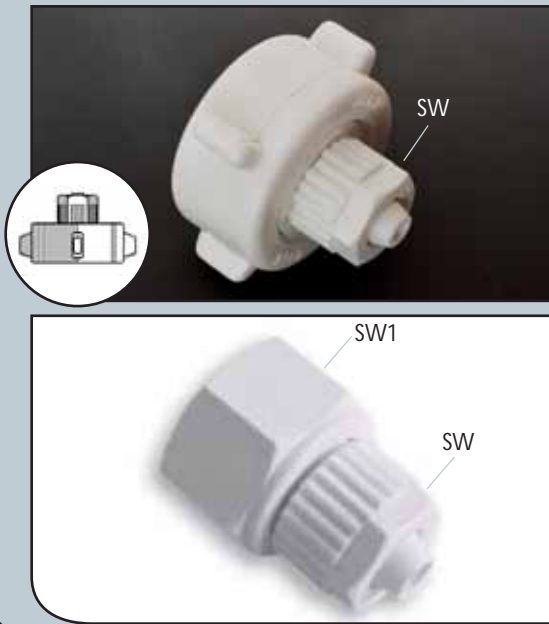

CAT. NO.	Tube O.D	Thread BSPT	SW mm
22044704121	1/4"	3/4"	14
22044746121	6 mm	3/4"	14
22044648121	8 mm	3/4"	14
22044750121	10 mm	3/4"	17
22044752121	12 mm	3/4"	19

CAT. NO.	Tube O.D	Thread BSPT	SW mm	SW1 mm
22044746061	6 mm	3/8"	14	20
22044746081	6 mm	1/2"	14	24
22044748061	8 mm	3/8"	14	20
22044748081	8 mm	1/2"	14	24
22044750081	10 mm	1/2"	17	24

Fiber glass reinforced polypropylene tube connectors feature barb onto which the tube is dressed and tightened with nut on inner and outer surfaces of tube. Note: 3/4" female swivel sealed with flat rubber seal.

Working Pressure: Up to 14 BAR (200 psi).

Advantages: Good resistance to chemicals and fertilizers.

Excellent for outdoor and field applications. Temperature: 90°C max.

→ FEMALE ELBOW SWIVEL CONNECTOR



CAT. NO.	Tube O.D	Thread BSPT	SW mm
22044548121	8 mm	3/4"	30

→ WATER PRE FILTER

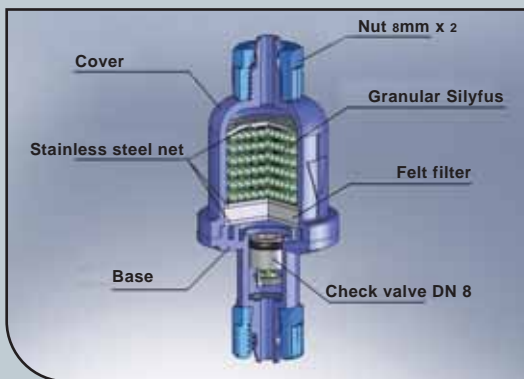

	Model White	Model Blue
	220467T9101	220467T9008
Filter Micron (mesh)	150 (100)	150 (100)
Maximum flow rate L/M	8	8
Maximum flow rate G/M	2.11	2.11
Hose connector inlet/outlet (inch)	8 mm (5/16")	8 mm (5/16")
Anti scale substance	-	✓
Check valve	-	✓
Diameter mm (inch)	32 (1 1/4")	32 (1 1/4")
Length mm (inch)	71.7 (2 13/16")	71.7 (2 13/16")

AGRICULTURE PIPE FITTINGS

Material: Polypropylene.

Colour: Black.

 Working pressure: Up to 14 BAR (200 psi) at 20°C.

 Temperature: 4°C + 90°C (subject to application).

Assembly: Tubes dressed onto barbed tail of fitting.
 Advantages: Good resistance to chemicals and fertilizers.
 Uses: Fittings especially suitable for connecting L.D.P.E. agricultural pipes, Class 2.5 and Class 4 and other flexible pipes.

→ **FEMALE SWIVEL HOSE CONNECTOR WITH WASHER**

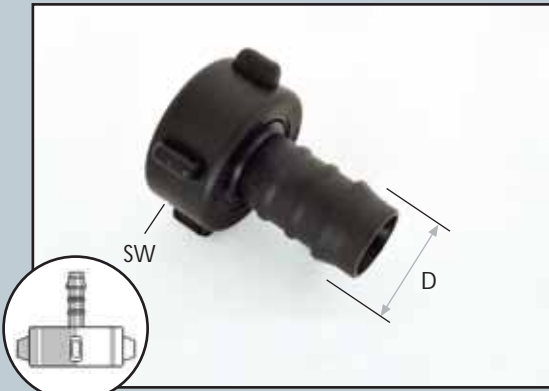

Polypropylene swivel hose connector with flat seal. Good resistance to chemicals and fertilizers. Suitable for outdoors use in irrigation systems and gardens.

CAT. NO.	D Hose I.D.	Thread BSP	SW mm
22454746122	6 mm	3/4"	32
22454748122	8 mm	3/4"	32
22454748162	8 mm	1"	38
22454750062	10 mm	3/8"	32
22454750122	10 mm	3/4"	32
22454752082	12 mm	1/2"	32
22454752122	12 mm	3/4"	32
22454752162	12 mm	1"	38
22454754122	14 mm	3/4"	32
22454754162	14 mm	1"	38
22454756122	16 mm	3/4"	32
22454756162	16 mm	1"	38
22454759122	19 mm	3/4"	32
22454759162	19 mm	1"	38
22454706122	3/8"	3/4"	32
22454708162	1/2"	1"	38
22454708122	1/2"	3/4"	32
22454710162	5/8"	1"	38
22454710122	5/8"	3/4"	32
22454712162	3/4"	1"	38
22454712122	3/4"	3/4"	32

→ **MALE STRAIGHT HOSE CONNECTOR**



CAT. NO.	Hose O.D	Thread BSPT	SW mm	
12456812022	12 mm	1/8"	14	
12456812042	12 mm	1/4"	14	
12456812062	12 mm	3/8"	17	
12456812082	12 mm	1/2"	22	
12456812122	12 mm	3/4"	27	
12456816042	16 mm	1/4"	22	
12456816082	16 mm	1/2"	22	
12456816122	16 mm	3/4"	27	
12456820082	20 mm	1/2"	22	
12456820122	20 mm	3/4"	27	
12456820162	20 mm	1"	29	
12456825082	25 mm	1/2"	22	
12456825122	25 mm	3/4"	27	
12456825162	25 mm	1"	29	
12466817083	17 mm	1/2"	27	SHARP BARB ACETAL
12466817123	17 mm	3/4"	27	SHARP BARB ACETAL

→ **UNION HOSE CONNECTOR**



CAT. NO.	Hose OD	Colour	
12456212002	12 mm		
12456220002	20 mm		
12456225002	25 mm		
12456216002	16 mm		
12466216002	16 mm	BLACK	SHARP BARB ACETAL
12466216003	16 mm	BROWN	SHARP BARB ACETAL
12466217003	17 mm	BROWN	SHARP BARB ACETAL

→ OD-Outer diameter → SW-Standard Wrench
 → ID-Inner diameter → R-Radius

→ OD-Outer diameter → SW-Standard Wrench
 → ID-Inner diameter → R-Radius

→ REDUCING HOSE CONNECTOR

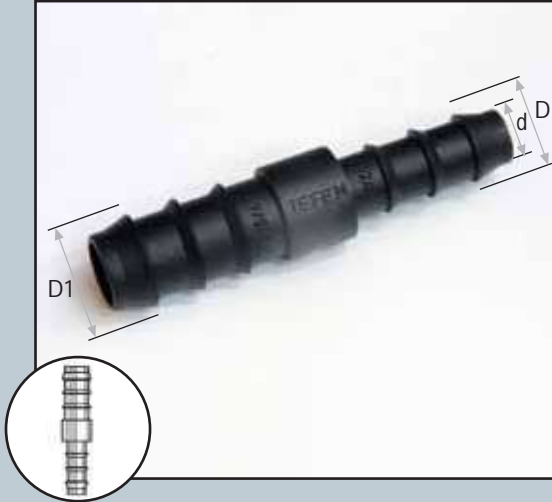

CAT. NO.	D Hose O.D	D1 Hose OD	d Hose ID	
12455648122		12 mm	8 mm	
12455612162	12 mm	16 mm		
12455612202	12 mm	20 mm		
12455616202	16 mm	20 mm		
12455620252	20 mm	25 mm		
12455652202		20 mm	12 mm	
12455656202		20 mm	16 mm	
12455659202		20 mm	19 mm	
12455659252		25 mm	19 mm	
12465612172	12 mm	17 mm		SHARP BARB ACETAL
12465616172	16 mm	17 mm		SHARP BARB ACETAL
12465617202	17 mm	20 mm		SHARP BARB ACETAL

→ MALE ELBOW HOSE CONNECTOR



CAT. NO.	Hose O.D	Thread BSPT	SW mm	
12456912042	12 mm	1/4"	14	
12456912062	12 mm	3/8"	14	
12456912082	12 mm	1/2"	22	
12456912122	12 mm	3/4"	27	
12456916062	16 mm	3/8"	22	
12456916082	16 mm	1/2"	22	
12456916122	16 mm	3/4"	27	
12456920082	20 mm	1/2"	22	
12456920122	20 mm	3/4"	27	
12456925082	25 mm	1/2"	27	
12456925122	25 mm	3/4"	27	
12466917083	17 mm	1/2"	22	SHARP BARB ACETAL
12466917123	17 mm	3/4"	22	SHARP BARB ACETAL

→ REDUCING ELBOW HOSE CONNECTOR



CAT. NO.	D Hose O.D	D1 Hose O.D	d Hose ID	
12456612162	12 mm	16 mm		
12456616202	16 mm	20 mm		
12456620252	20 mm	25 mm		
12456612202	12 mm	20 mm		
12456652202		20 mm	12 mm	
12456656202		20 mm	16 mm	
12456659202		20 mm	19 mm	
12456659252		25 mm	19 mm	

→ ELBOW HOSE CONNECTOR



CAT. NO.	Hose O.D	
12456512002	12 mm	SHARP BARB ACETAL SHARP BARB ACETAL
12456516002	16 mm	
12456520002	20 mm	
12456525002	25 mm	
12466516003	16 mm	
12466517003	17 mm	

→ MALE BRANCHT HOSE CONNECTOR



CAT. NO.	Hose O.D	Thread BSPT	SW mm	
12457112042	12 mm	1/4"	14	SHARP BARB ACETAL SHARP BARB ACETAL
12457112062	12 mm	3/8"	22	
12457112082	12 mm	1/2"	22	
12457112122	12 mm	3/4"	27	
12457116062	16 mm	3/8"	17	
12457116082	16 mm	1/2"	22	
12457116122	16 mm	3/4"	27	
12457120082	20 mm	1/2"	22	
12457120122	20 mm	3/4"	27	
12457125082	25 mm	1/2"	22	
12457125122	25 mm	3/4"	27	
12467117083	17 mm	1/2"	22	
12467117123	17 mm	3/4"	27	

→ T HOSE CONNECTOR



CAT. NO.	Hose O.D	
12456412122	12 mm	SHARP BARB ACETAL SHARP BARB ACETAL
12456416162	16 mm	
12456420202	20 mm	
12456425252	25 mm	
12466416163	16 mm	
12466417173	17 mm	

→ REDUCING T HOSE CONNECTOR



CAT. NO.	D Hose O.D	D1 Hose O.D	d Hose I.D
12457212162	12 mm	16 mm	6 mm 12 mm 16 mm 19 mm
12457216202	16 mm	20 mm	
12457220252	20 mm	25 mm	
12457246162		16 mm	
12457252202		20 mm	
12457256202		20 mm	
12457259202		20 mm	

→ OD-Outer diameter → SW-Standard Wrench
→ ID-Inner diameter → R-Radius

INDUSTRIAL HOSE FITTINGS

Material: Nylon 66.
Colours: Blue or Gray.

Available in **PVDF** upon demand.
Colour: Natural.

 Working pressure: Up to 14 BAR (200 psi) at 20°C.

 Temperature: -20°C + 110°C (subject to application).
Assembly: Tubes dressed onto barbed tail of fitting and secured with Tefen snap clip (page 23).
Advantages: Strong and durable.
Uses: Fittings especially suitable for connecting plastic, rubber or soft p.v.c. hoses in industrial and domestic applications. As these hoses have various wall thicknesses the size is by ID measurement.

→ **FEMALE THREADED STRAIGHT HOSE CONNECTOR**

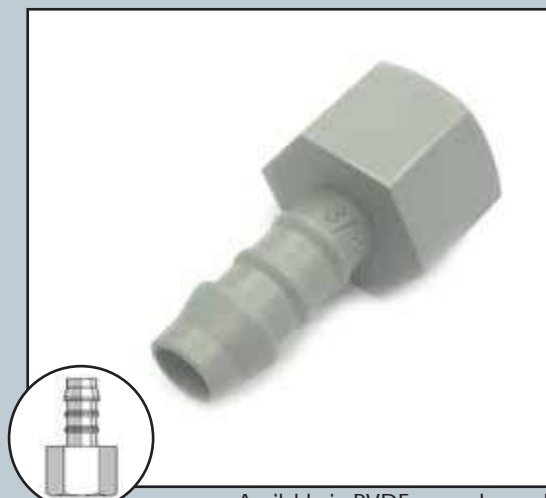

Available in PVDF upon demand

CAT. NO.	Hose ID	Thread BSPT	Color
12446745028	5 mm	1/8"	
12446745048	5 mm	1/4"	
12446745068	5 mm	3/8"	
12446745088	5 mm	1/2"	
12446746028	6 mm	1/8"	
12446746048	6 mm	1/4"	
12446746068	6 mm	3/8"	
12446746088	6 mm	1/2"	
12446748028	8 mm	1/8"	
12446748041	8 mm	1/4"	
12446748048	8 mm	1/4"	
12446748068	8 mm	3/8"	
12446748088	8 mm	1/2"	
12446750048	10 mm	1/4"	
12446750068	10 mm	3/8"	
12446750088	10 mm	1/2"	
12446752048	12 mm	1/4"	
12446752068	12 mm	3/8"	
12446752088	12 mm	1/2"	
12446754068	14 mm	3/8"	
12446754088	14 mm	1/2"	
12446756088	16 mm	1/2"	
12446759088	19 mm	1/2"	

CAT. NO.	Hose ID	Thread NPT	Color
12256704023	1/4"	1/8"	
12256704043	1/4"	1/4"	
12256704063	1/4"	3/8"	
12256704083	1/4"	1/2"	
12256705023	5/16"	1/8"	
12256705043	5/16"	1/4"	
12256705063	5/16"	3/8"	
12256705083	5/16"	1/2"	
12256706043	3/8"	1/4"	
12256706063	3/8"	3/8"	
12256706083	3/8"	1/2"	
12256708043	1/2"	1/4"	
12256708063	1/2"	3/8"	
12256708083	1/2"	1/2"	
12256709063	9/16"	3/8"	
12256709083	9/16"	1/2"	
12256710083	5/8"	1/2"	
12256712083	3/4"	1/2"	

→ OD-Outer diameter → SW-Standard Wrench
→ ID-Inner diameter → R-Radius

→ MALE THREADED STRAIGHT HOSE CONNECTOR



Available in PVDF upon demand

CAT. NO.	Hose I.D	Thread BSPT	SWmm	Color
12446844028	4 mm	1/8"	11	Blue
12446844048	4 mm	1/4"	14	Blue
12446845028	5 mm	1/8"	11	Blue
12446845048	5 mm	1/4"	14	Blue
12446846028	6 mm	1/8"	11	Blue
12446846048	6 mm	1/4"	14	Blue
12446846068	6 mm	3/8"	17	Blue
12446846088	6 mm	1/2"	22	Blue
12446846128	6 mm	3/4"	22	Blue
12446848028	8 mm	1/8"	11	Blue
12446848048	8 mm	1/4"	14	Blue
12446848068	8 mm	3/8"	17	Blue
12446848088	8 mm	1/2"	22	Blue
12446848128	8 mm	3/4"	17	Blue
12446850048	10 mm	1/4"	14	Blue
12446850068	10 mm	3/8"	17	Blue
12446850088	10 mm	1/2"	22	Blue
12446850128	10 mm	3/4"	27	Blue
12446852048	12 mm	1/4"	14	Blue
12446852068	12 mm	3/8"	17	Blue
12446852088	12 mm	1/2"	22	Blue
12446852128	12 mm	3/4"	27	Blue
12446854068	14 mm	3/8"	17	Blue
12446854088	14 mm	1/2"	22	Blue
12446854128	14 mm	3/4"	27	Blue
12446856088	16 mm	1/2"	22	Blue
12446856128	16 mm	3/4"	27	Blue
12446859088	19 mm	1/2"	22	Blue
12446859128	19 mm	3/4"	27	Blue
12446859168	19 mm	1"	36	Blue
12446865128	25 mm	3/4"	27	Blue
12446865168	25 mm	1"	36	Blue

→ SPECIAL PANEL MALE STRAIGHT HOSE CONNECTOR



Available in PVDF upon demand

CAT. NO.	D Hose I.D	Thread NPT	SW mm	Color
12256802023	5/32"	1/8"	11	Grey
12256802043	5/32"	1/4"	14	Grey
12256803023	3/16"	1/8"	11	Grey
12256803043	3/16"	1/4"	14	Grey
12256804023	1/4"	1/8"	17	Grey
12256804043	1/4"	1/4"	22	Grey
12256804063	1/4"	3/8"	11	Grey
12256804083	1/4"	1/2"	14	Grey
12256805023	5/16"	1/8"	17	Grey
12256805043	5/16"	1/4"	22	Grey
12256805063	5/16"	3/8"	14	Grey
12256805083	5/16"	1/2"	22	Grey
12256806043	3/8"	1/4"	22	Grey
12256806063	3/8"	3/8"	27	Grey
12256806083	3/8"	1/2"	22	Grey
12256806123	3/8"	3/4"	27	Grey
12256808043	1/2"	1/4"	22	Grey
12256808063	1/2"	3/8"	17.5	Grey
12256808083	1/2"	1/2"	27	Grey
12256808123	1/2"	3/4"	22	Grey
12256809063	9/16"	3/8"	27	Grey
12256809083	9/16"	1/2"	22	Grey
12256809123	9/16"	3/4"	27	Grey
12256810083	5/8"	1/2"	22	Grey
12256810123	5/8"	3/4"	27	Grey
12256812083	3/4"	1/2"	22	Grey
12256812123	3/4"	3/4"	27	Grey

→ FLANGE MOUNTING MALE STRAIGHT HOSE CONNECTOR



Available in PVDF upon demand

12P46850088	10 mm	1/2"	27	Blue
12P56806083	10 mm	1/2"	27	Grey

CAT. NO.	D Hose I.D	Thread BSPT	SW mm	Color
12F46850088	10 mm	1/2"	22	Blue

→ OD-Outer diameter → SW-Standard Wrench
→ ID-Inner diameter → R-Radius

→ MALE THREADED ELBOW HOSE CONNECTOR



Available in PVDF upon demand

CAT. NO.	D Hose I.D	Thread BSPT	SW mm	Color
12446944028	4 mm	1/8"	11	
12446944048	4 mm	1/4"	14	
12446945028	5 mm	1/8"	11	
12446945048	5 mm	1/4"	14	
12446945088	5 mm	1/2"	22	
12446946028	6 mm	1/8"	11	
12446946048	6 mm	1/4"	14	
12446946068	6 mm	3/8"	17	
12446946088	6 mm	1/2"	22	
12446948028	8 mm	1/8"	11	
12446948048	8 mm	1/4"	14	
12446948068	8 mm	3/8"	17	
12446948088	8 mm	1/2"	22	
12446950048	10 mm	1/4"	14	
12446950068	10 mm	3/8"	17	
12446950088	10 mm	1/2"	22	
12446950128	10 mm	3/4"	27	
12446952048	12 mm	1/4"	14	
12446952068	12 mm	3/8"	17	
12446952088	12 mm	1/2"	22	
12446952128	12 mm	3/4"	27	
12446954068	14 mm	3/8"	17	
12446954088	14 mm	1/2"	22	
12446954128	14 mm	3/4"	27	
12446956088	16 mm	1/2"	22	
12446956128	16 mm	3/4"	27	
12446959088	19 mm	1/2"	22	
12446959128	19 mm	3/4"	27	

CAT. NO.	D Hose I.D	Thread NPT	SW mm	Color
12256902023	5/32"	1/8"	11	
12256902043	5/32"	1/4"	14.5	
12256903023	3/16"	1/8"	11	
12256903043	3/16"	1/4"	14.5	
12256903083	3/16"	1/2"	22	
12256904023	1/4"	1/8"	11	
12256904043	1/4"	1/4"	14.5	
12256904063	1/4"	3/8"	18	
12256904083	1/4"	1/2"	24	
12256905023	5/16"	1/8"	11	
12256905043	5/16"	1/4"	14.5	
12256905063	5/16"	3/8"	18	
12256905083	5/16"	1/2"	24	
12256906043	3/8"	1/4"	14.5	
12256906063	3/8"	3/8"	18	
12256906083	3/8"	1/2"	24	
12256906123	3/8"	3/4"	27	
12256908043	1/2"	1/4"	14.5	
12256908063	1/2"	3/8"	18	
12256908083	1/2"	1/2"	24	
12256908123	1/2"	3/4"	27	
12256909063	9/16"	3/8"	18	
12256909083	9/16"	1/2"	24	
12256909123	9/16"	3/4"	27	
12256910083	5/8"	1/2"	24	
12256910123	5/8"	3/4"	27	
12256912083	3/4"	1/2"	24	
12256912123	3/4"	3/4"	27	

→ MALE THREADED ELBOW HOSE CONNECTOR - FLANGE



Available in PVDF upon demand

CAT. NO.	D Hose I.D	Thread BSPT	SW mm	Color
12F46950068	10 mm	3/8"	17	
12F46950088	10 mm	1/2"	22	

→ REDUCING ELBOW HOSE CONNECTOR

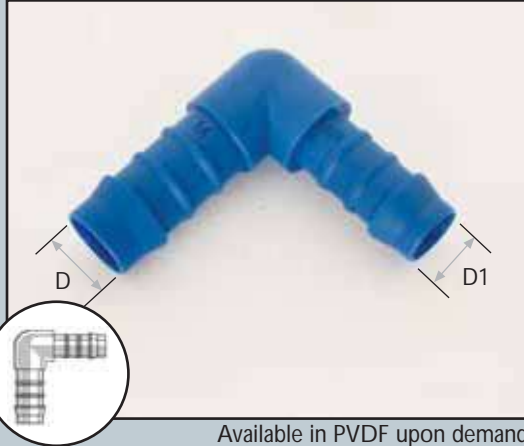

Available in PVDF upon demand

CAT. NO.	D Hose I.D	D1 Hose I.D	Color
12446645448	5 mm	4 mm	Blue
12446646458	6 mm	5 mm	
12446648468	8 mm	6 mm	
12446650468	10 mm	6 mm	
12446650488	10 mm	8 mm	
12446652508	12 mm	10 mm	
12446654528	14 mm	12 mm	
12446656548	16 mm	14 mm	
12446659568	19 mm	16 mm	
12256603023	3/16"	5/32"	Grey
12256604033	1/4"	3/16"	
12256605043	5/16"	1/4"	
12256606043	3/8"	1/4"	
12256606053	3/8"	5/16"	
12256608063	1/2"	3/8"	
12256609083	9/16"	1/2"	
12256610093	5/8"	9/16"	
12256612103	3/4"	5/8"	

→ ELBOW HOSE CONNECTOR



Available in PVDF upon demand

CAT. NO.	Hose I.D	Color
12446544008	4 mm	Blue
12446545008	5 mm	
12446546008	6 mm	
12446548008	8 mm	
12446550008	10 mm	
12446552008	12 mm	
12446554008	14 mm	
12446556008	16 mm	
12446559008	19 mm	
12256502003	5/32"	Grey
12256503003	3/16"	
12256504003	1/4"	
12256505003	5/16"	
12256506003	3/8"	
12256508003	1/2"	
12256509003	9/16"	
12256510003	5/8"	
12256512003	3/4"	

→ REDUCING HOSE CONNECTOR

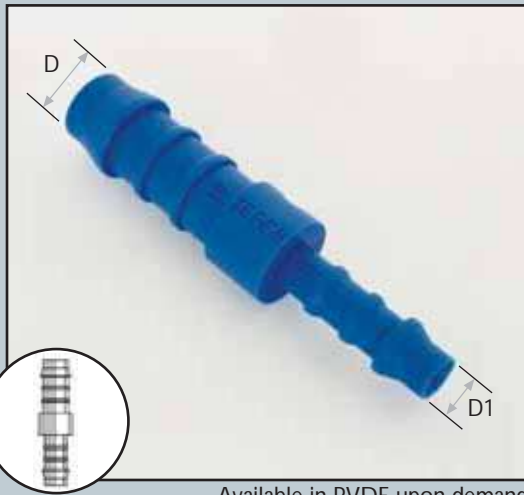

Available in PVDF upon demand

CAT. NO.	D Hose I.D	D1 Hose I.D	Color
12445645448	5 mm	4 mm	Blue
12445646448	6 mm	4 mm	
12445646458	6 mm	5 mm	
12445648458	8 mm	5 mm	
12445648468	8 mm	6 mm	
12445650468	10 mm	6 mm	
12445650488	10 mm	8 mm	
12445652488	12 mm	8 mm	
12445652508	12 mm	10 mm	
12445654508	14 mm	10 mm	
12445654528	14 mm	12 mm	
12445656528	16 mm	12 mm	
12445656548	16 mm	14 mm	
12445659548	19 mm	14 mm	
12445659568	19 mm	16 mm	
12255603023	3/16"	5/32"	
12255604023	1/4"	5/32"	
12255604033	1/4"	3/16"	
12255605033	5/16"	3/16"	
12255605043	5/16"	1/4"	
12255606043	3/8"	1/4"	
12255606053	3/8"	5/16"	
12255608053	1/2"	5/16"	
12255608063	1/2"	3/8"	
12255609063	9/16"	3/8"	
12255609083	9/16"	1/2"	
12255610083	5/8"	1/2"	
12255610093	5/8"	9/16"	
12255612093	3/4"	9/16"	
12255612103	3/4"	5/8"	

→ OD-Outer diameter → SW-Standard Wrench
→ ID-Inner diameter → R-Radius

→ OD-Outer diameter → SW-Standard Wrench
→ ID-Inner diameter → R-Radius

→ HOSE CONNECTOR

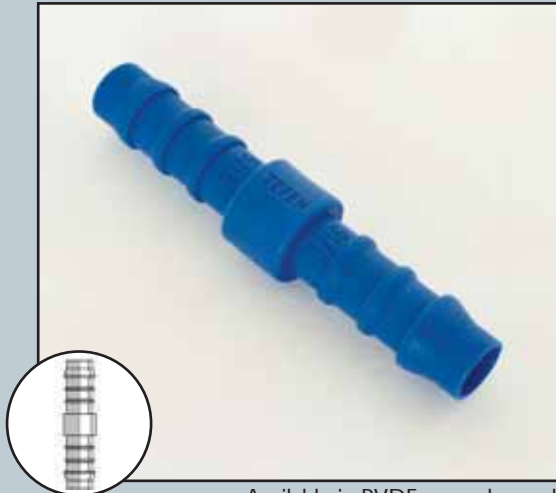

Available in PVDF upon demand

CAT. NO.	Hose I.D	Color
12446244008	4 mm	
12446245008	5 mm	
12446246008	6 mm	
12446248008	8 mm	
12446250008	10 mm	
12446252008	12 mm	
12446254008	14 mm	
12446256008	16 mm	
12446259008	19 mm	
12256202003	5/32"	
12256203003	3/16"	
12256204003	1/4"	
12256205003	5/16"	
12256206003	3/8"	
12256208003	1/2"	
12256209003	9/16"	
12256210003	5/8"	
12256211003	11/16"	
12256212003	3/4"	

→ Y HOSE CONNECTOR

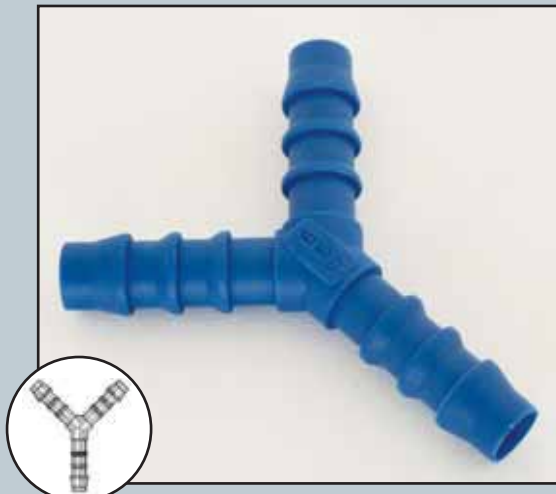

CAT. NO.	Hose I.D	Color
12446344448	4 mm	
12446346468	6 mm	
12446348488	8 mm	
12446350508	10 mm	
12446357578	17 mm	
12256302023	5/32"	
12256304043	1/4"	
12256305053	5/16"	
12256306063	3/8"	
12256311113	11/16"	

→ UNION T HOSE CONNECTOR



Available in PVDF upon demand

CAT. NO.	Hose I.D	Color
12446444448	4 mm	
12446445458	5 mm	
12446446468	6 mm	
12446448488	8 mm	
12446450508	10 mm	
12446452528	12 mm	
12446454548	14 mm	
12446456568	16 mm	
12446459598	19 mm	
12256402023	5/32"	
12256403033	3/16"	
12256404043	1/4"	
12256405053	5/16"	
12256406063	3/8"	
12256408083	1/2"	
12256409093	9/16"	
12256410103	5/8"	
12256412123	3/4"	

→ MALE BRANCH T HOSE CONNECTOR

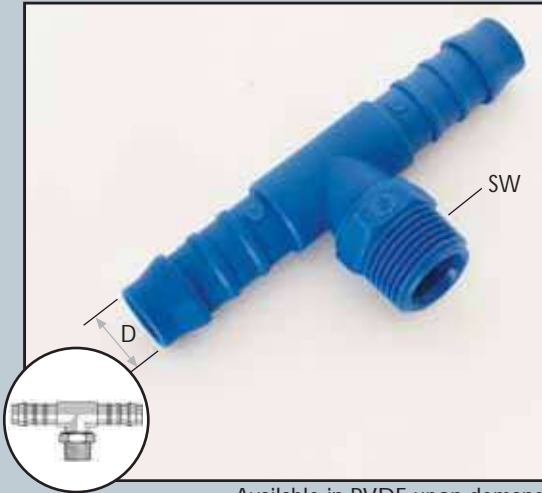

Available in PVDF upon demand

CAT. NO.	D Hose I.D	Thread BSPT	SW mm	Color
12447144028	4 mm	1/8"	11	Blue
12447144048	4 mm	1/4"	14	Blue
12447145028	5 mm	1/8"	11	Blue
12447145048	5 mm	1/4"	14	Blue
12447146028	6 mm	1/8"	11	Blue
12447146048	6 mm	1/4"	14	Blue
12447146068	6 mm	3/8"	17	Blue
12447146088	6 mm	1/2"	22	Blue
12447148028	8 mm	1/8"	11	Blue
12447148048	8 mm	1/4"	14	Blue
12447148068	8 mm	3/8"	17	Blue
12447148088	8 mm	1/2"	22	Blue
12447150048	10 mm	1/4"	14	Blue
12447150068	10 mm	3/8"	17	Blue
12447150088	10 mm	1/2"	22	Blue
12447150128	10 mm	3/4"	27	Blue
12447152048	12 mm	1/4"	14	Blue
12447152068	12 mm	3/8"	17	Blue
12447152088	12 mm	1/2"	22	Blue
12447152128	12 mm	3/4"	27	Blue
12447154068	14 mm	3/8"	17	Blue
12447154088	14 mm	1/2"	22	Blue
12447154128	14 mm	3/4"	27	Blue
12447156088	16 mm	1/2"	22	Blue
12447156128	16 mm	3/4"	27	Blue
12447159088	19 mm	1/2"	22	Blue
12447159128	19 mm	3/4"	27	Blue

→ FLANGE BRANCH T HOSE CONNECTOR



Available in PVDF upon demand

CAT. NO.	D Hose I.D	Thread NPT	SW mm	Color
12257102023	5/32"	1/8"	11	Grey
12257102043	5/32"	1/4"	14.5	Grey
12257103023	3/16"	1/8"	11	Grey
12257103043	3/16"	1/4"	14.5	Grey
12257103083	3/16"	1/2"	24	Grey
12257104023	1/4"	1/8"	11	Grey
12257104043	1/4"	1/4"	14.5	Grey
12257104063	1/4"	3/8"	18	Grey
12257104083	1/4"	1/2"	24	Grey
12257105023	5/16"	1/8"	11	Grey
12257105043	5/16"	1/4"	14.5	Grey
12257105063	5/16"	3/8"	18	Grey
12257105083	5/16"	1/2"	24	Grey
12257106043	3/8"	1/4"	14.5	Grey
12257106063	3/8"	3/8"	18	Grey
12257106083	3/8"	1/2"	24	Grey
12257106123	3/8"	3/4"	27	Grey
12257108043	1/2"	1/4"	14.5	Grey
12257108063	1/2"	3/8"	18	Grey
12257108083	1/2"	1/2"	24	Grey
12257108123	1/2"	3/4"	27	Grey
12257109063	9/16"	3/8"	18	Grey
12257109083	9/16"	1/2"	24	Grey
12257109123	9/16"	3/4"	27	Grey
12257110083	5/8"	1/2"	24	Grey
12257110123	5/8"	3/4"	27	Grey
12257112083	3/4"	1/2"	24	Grey
12257112123	3/4"	3/4"	27	Grey

CAT. NO.	D Hose I.D	Thread BSPT	SW mm	Color
12F47150068	10 mm	3/8"	17	Blue
12F47150088	10 mm	1/2"	22	Blue

→ OD-Outer diameter → SW-Standard Wrench
→ ID-Inner diameter → R-Radius

→ REDUCING T HOSE CONNECTOR

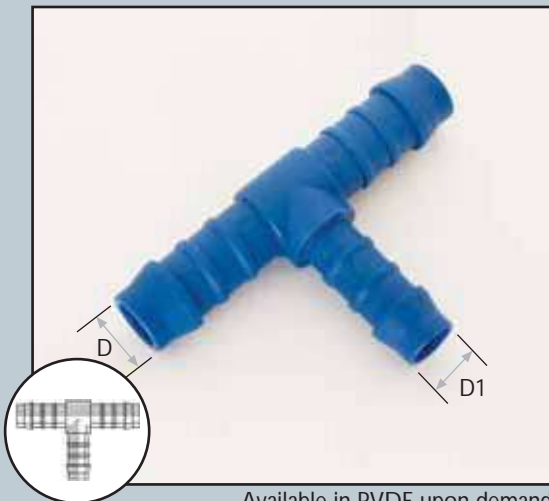

Available in PVDF upon demand

CAT. NO.	D Hose I.D	D1 Hose I.D	Color
12447245448	5 mm	4 mm	
12447246458	6 mm	5 mm	
12447248468	8 mm	6 mm	
12447250488	10 mm	8 mm	
12447252508	12 mm	10 mm	
12447254528	14 mm	12 mm	
12447256548	16 mm	14 mm	
12447259568	19 mm	16 mm	
12257203023	3/16"	5/32"	
12257204033	1/4"	3/16"	
12257205043	5/16"	1/4"	
12257206053	3/8"	5/16"	
12257208063	1/2"	3/8"	
12257209083	9/16"	1/2"	
12257210093	5/8"	9/16"	
12257212103	3/4"	5/8"	

→ FEMALE SWIVEL STRAIGHT HOSE CONNECTOR - CONICAL SEAT

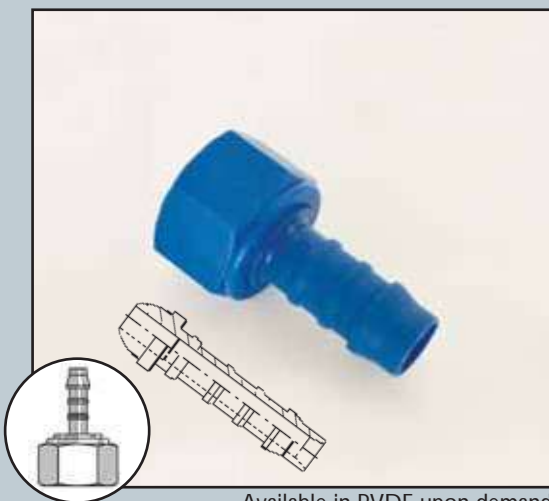

Available in PVDF upon demand

Nylon Swivel connector with conical seat tube dressed onto barbed tail and secured with Tefen snap clip (page 25). Suitable for plastic, rubber and soft P.V.C. hoses. Colour: Blue. Temperature: Max 90°C

CAT. NO.	Hose I.D	Thread BSP	SW mm	Colour
22444644028	4 mm	1/8"	13	
22444645028	5 mm	1/8"	13	
22444644048	4 mm	1/4"	16	
22444645048	5 mm	1/4"	16	
22444646048	6 mm	1/4"	16	
22444648048	8 mm	1/4"	16	
22444645068	5 mm	3/8"	20	
22444646068	6 mm	3/8"	20	
22444648068	8 mm	3/8"	20	
22444650068	10 mm	3/8"	20	
22444646088	6 mm	1/2"	24	
22444648088	8 mm	1/2"	24	
22444650088	10 mm	1/2"	24	
22444652088	12 mm	1/2"	24	
22444654088	14 mm	1/2"	24	
22444648128	8 mm	3/4"	30	
22444650128	10 mm	3/4"	30	
22444652128	12 mm	3/4"	30	
22444654128	14 mm	3/4"	30	
22444656128	16 mm	3/4"	30	
22444659128	19 mm	3/4"	30	
22444648042	8 mm	1/4"	16	
22444650062	10 mm	3/8"	20	
22444652082	12 mm	1/2"	24	

→ FEMALE SWIVEL STRAIGHT HOSE CONNECTOR

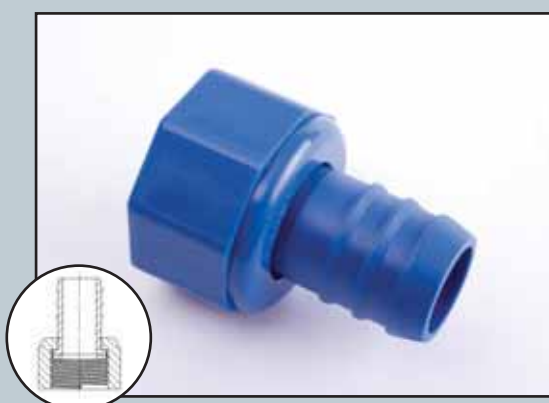

Available in PVDF upon demand

CAT. NO.	Hose I.D.	Thread BSP	SW mm
22454765168	24 mm	1"	44

→ FLANGE PIPE ELBOW



Available in PVDF upon demand

CAT. NO.	Thread BSPT	SW mm
12016506L08	3/8"	12

→ SNAP CLIP ACETAL



CAT. NO.	R	D mm
17090010002	R-8	8-10
17090012002	R-10	10-12
17090013002	R-11	11-13
17090015002	R-13	13-15
17090016002	R-14	14-16
17090017002	R-15	15-17
17090018002	R-16	16-18
17090019002	R-17	17-19
17090020002	R-18	18-20
17090021002	R-20	20-22
17090023002	R-21	21-23
17090025002	R-23	23-25
17090028002	R-26	26-28
17090032002	R-30	30-32
17090037002	R-35	35-37
17090046002	R-44	44-46
17090049002	R-47	47-49

SNAP CLIP

Material: Acetal resin
 Colour: Black.
 Working pressure: Up to 14 BAR (200 psi).
 Temperature: -4°C + 90°C (after fitting).
 Assembly: With hose in place locate snap clip around the hose and simple manual pressure will ensure a snug joint. Use plier to tighten. Release by applying lateral pressure.
 Advantages: Strong and durable. Reusable.



→ OD-Outer diameter → SW-Standard Wrench
 → ID-Inner diameter → R-Radius

ADAPTORS



Material: Nylon 66.
 Colour: Blue.
 Working pressure: Up to 14 BAR (200 psi).



Temperature: -20°C +110°C (subject to application).
 These fittings are supplementary to all other fittings enabling various adapting combinations.

→ **PANEL MOUNTING NUT**

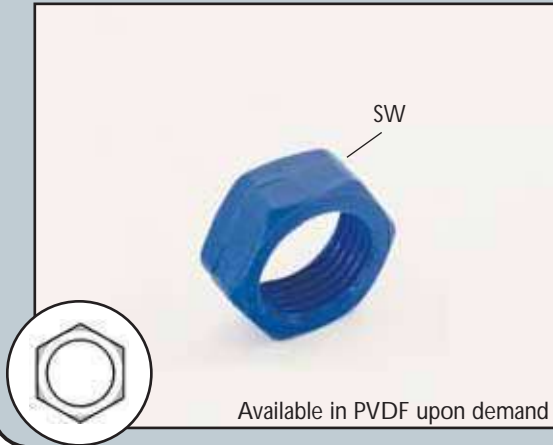

CAT. NO.	Colour	Thread BSPT	SW mm
32006100042	Black	1/4"	15
32006100081	White (thin)	1/2"	25.5
32006100082	Black	1/2"	25.5
32006100088	Blue	M20	Ø 28
32006100201	White	1/2"	25.5

→ **PIPE REDUCING NIPPLE**



CAT. NO.	R Thread BSPT	R1 Thread BSPT	SW mm	Color
12012304028	1/4"	1/8"	17	
12012306028	3/8"	1/8"	19	
12012306048	3/8"	1/4"	19	
12012308048	1/2"	1/4"	22	
12012308068	1/2"	3/8"	22	

CAT. NO.	R Thread NPT	R1 Thread NPT	SW mm	Color
12022304023	1/4"	1/8"	14.5	
12022306023	3/8"	1/8"	17.5	
12022308023	1/2"	1/8"	22	
12022312023	3/4"	1/8"	27	
12022306043	3/8"	1/4"	17.5	
12022308043	1/2"	1/4"	22	
12022312043	3/4"	1/4"	27	
12022308063	1/2"	3/8"	22	
12022312063	3/4"	3/8"	27	
12022312083	3/4"	1/2"	27	

→ **PIPE HEX NIPPLE**



CAT. NO.	Thread BSPT	SW mm	Color
12012202028	1/8"	14	
12012204048	1/4"	17	
12012206068	3/8"	19	
12012208088	1/2"	22	

CAT. NO.	Thread NPT	SW mm	Color
12022202023	1/8"	11	
12022204043	1/4"	14.5	
12022206063	3/8"	17.5	
12022208083	1/2"	22	
12022212123	3/4"	27	

→ OD-Outer diameter → SW-Standard Wrench
 → ID-Inner diameter → R-Radius

→ P I P E A D A P T O R

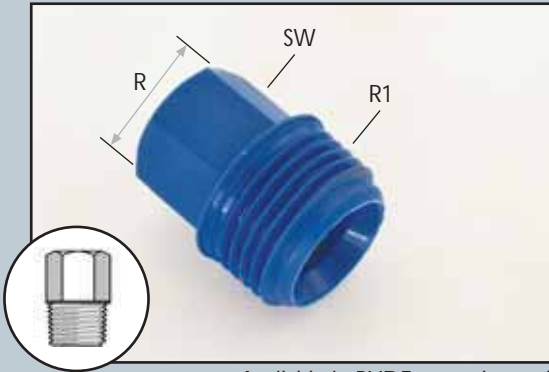

Available in PVDF upon demand

CAT. NO.	R Thread BSPT	R1 Thread BSPT	SW mm	Color
12012002028	1/8"	1/8"	14	
12012002048	1/8"	1/4"	14	
12012002068	1/8"	3/8"	14	
12012002088	1/8"	1/2"	14	
12012004028	1/4"	1/8"	17	
12012004048	1/4"	1/4"	17	
12012004068	1/4"	3/8"	17	
12012004088	1/4"	1/2"	17	
12012006028	3/8"	1/8"	22	
12012006048	3/8"	1/4"	22	
12012006068	3/8"	3/8"	22	
12012006088	3/8"	1/2"	22	
12012008028	1/2"	1/8"	26	
12012008048	1/2"	1/4"	26	
12012008068	1/2"	3/8"	26	
12012008088	1/2"	1/2"	26	

CAT. NO.	R Thread NPT	R1 Thread NPT	SW mm	Color
12022002023	1/8"	1/8"	14	
12022002043	1/8"	1/4"	14	
12022002063	1/8"	3/8"	14	
12022002083	1/8"	1/2"	14	
12022004023	1/4"	1/8"	17	
12022004043	1/4"	1/4"	17	
12022004063	1/4"	3/8"	17	
12022004083	1/4"	1/2"	17	
12022006023	3/8"	1/8"	22	
12022006043	3/8"	1/4"	22	
12022006063	3/8"	3/8"	22	
12022006083	3/8"	1/2"	22	
12022008023	1/2"	1/8"	26	
12022008043	1/2"	1/4"	26	
12022008063	1/2"	3/8"	26	
12022008083	1/2"	1/2"	26	

→ P I P E B U S H I N G

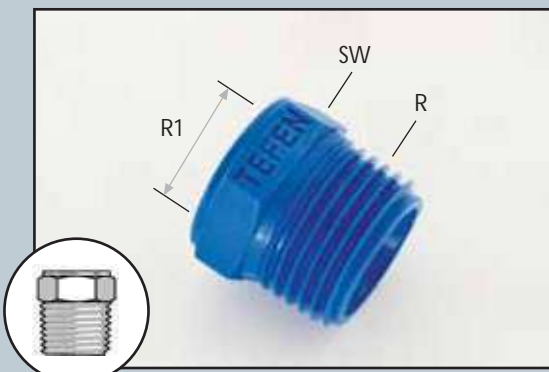

Available in PVDF upon demand

CAT. NO.	R Thread BSPT	R1 Thread BSPT	SW mm	Color
12011004028	1/4"	1/8"	14	
12011006028	3/8"	1/8"	17	
12011006048	3/8"	1/4"	17	
12011008028	1/2"	1/8"	22	
12011008048	1/2"	1/4"	22	
12011008068	1/2"	3/8"	22	
12011012048	3/4"	1/4"	27	
12011012068	3/4"	3/8"	27	
12011012088	3/4"	1/2"	27	

CAT. NO.	R Thread NPT	R1 Thread NPT	SW mm	Color
12021004023	1/4"	1/8"	14	
12021006023	3/8"	1/8"	18.5	
12021006043	3/8"	1/4"	18.5	
12021008023	1/2"	1/8"	24	
12021008043	1/2"	1/4"	24	
12021008063	1/2"	3/8"	24	
12021012043	3/4"	1/4"	29	
12021012063	3/4"	3/8"	29	
12021012083	3/4"	1/2"	29	

→ OD-Outer diameter → SW-Standard Wrench
→ ID-Inner diameter → R-Radius

→ FEMALE PIPE COUPLING



CAT. NO.	Thread BSPT	SW mm	Colour
12010302021	1/8"	14	
12010304042	1/4"	17	
12010302028	1/8"	14	
12010304048	1/4"	17	
12010306068	3/8"	21	
12010308088	1/2"	26	
12010312122	3/4"	34	
12010312128	3/4"	34	

CAT. NO.	Thread NPT	SW mm	Colour
12020302023	1/8"	14	
12020304043	1/4"	17	
12020306063	3/8"	21	
12020308083	1/2"	26	

→ THREADED ELBOW



CAT. NO.	Thread BSPT	SW mm	Colour
12016502002	1/8"	10	
12016504001	1/4"	10	
12016504002	1/4"	10	
12016504007	1/4"	10	
12016502008	1/8"	10	
12016504008	1/4"	10	
12016506008	3/8"	14	
12016508008	1/2"	17	

CAT. NO.	Thread NPT	SW mm	Colour
12026502003	1/8"	10	
12026504003	1/4"	10	

→ THREADED REDUCING ELBOW

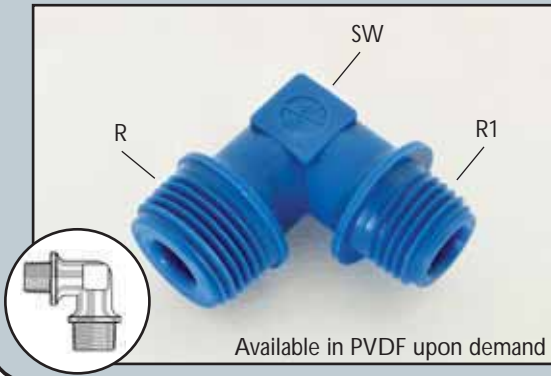

CAT. NO.	R Thread BSPT	R1 Thread BSPT	SW mm	Color
12016904028	1/4"	1/8"	10	
12016906048	3/8"	1/4"	15	
12016908068	1/2"	3/8"	17	

CAT. NO.	R Thread NPT	R1 Thread NPT	SW mm	Color
12026904023	1/4"	1/8"	10	

→ HEX THREADED PLUG

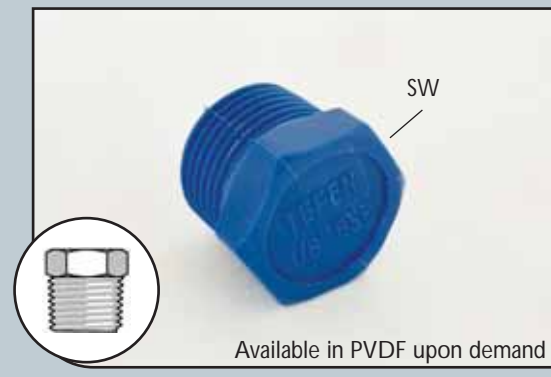

CAT. NO.	Thread BSPT	SW mm	Color
12012104001	1/4"	15	
12012104002	1/4"	15	
12012102008	1/8"	12	
12012104008	1/4"	15	
12012106008	3/8"	17	
12012108008	1/2"	22	
12012112008	3/4"	30	
12012116008	1"	36	

CAT. NO.	Thread NPT	SW mm	Color
12022102003	1/8"	12	
12022104003	1/4"	14	
12022106003	3/8"	17	
12022108003	1/2"	22	
12022112003	3/4"	30	

→ HEX THREADED FLANGE PLUG



Available in PVDF upon demand

CAT. NO.	Thread BSPT	SW mm
12012108L08	1/2"	22

→ P I P E C A P

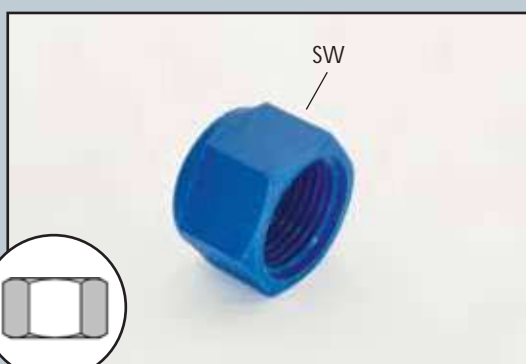

Available in PVDF upon demand

CAT. NO.	Thread BSPT	SW mm	Color
12010802008	1/8"	13	
12010804008	1/4"	16	
12010806008	3/8"	20	
12010808008	1/2"	25	
12010812008	3/4"	30	

CAT. NO.	Thread NPT	SW mm	Color
12020802003	1/8"	14	
12020804003	1/4"	17	
12020806003	3/8"	22	
12020808003	1/2"	26	
12020812003	3/4"	29	

→ PIPE REDUCING COUPLING

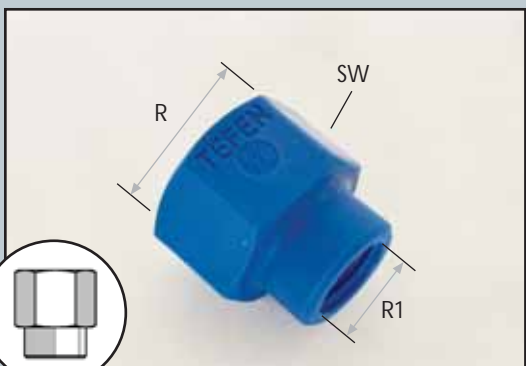

Available in PVDF upon demand

CAT. NO.	R Thread BSPT	R1 Thread BSPT	SW mm	Color
12011904028	1/4"	1/8"	17	
12011906028	3/8"	1/8"	21	
12011906048	3/8"	1/4"	21	
12011908048	1/2"	1/4"	26	
12011908068	1/2"	3/8"	26	
12011912048	3/4"	1/4"	30	
12011912088	3/4"	1/2"	30	
12011912042	3/4"	1/4"	30	
12011912068	3/4"	3/8"	30	
12011912082	3/4"	1/2"	30	

CAT. NO.	R Thread NPT	R1 Thread NPT	SW mm	Color
12021904023	1/4"	1/8"	17	
12021906023	3/8"	1/8"	21	
12021906043	3/8"	1/4"	21	
12021908043	1/2"	1/4"	26	
12021908063	1/2"	3/8"	26	

→ OD-Outer diameter → SW-Standard Wrench
→ ID-Inner diameter → R-Radius

→ P I P E T

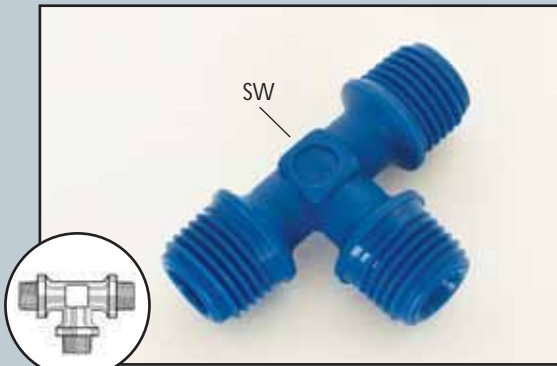

Available in PVDF upon demand

CAT. NO.	Thread BSPT	SW mm	Color
12016402008	1/8"	12	
12016404008	1/4"	12	
12016406008	3/8"	15	
12016408008	1/2"	17	
CAT. NO.	Thread NPT	SW mm	Color
12026402003	1/8"	12	
12026404003	1/4"	12	

→ PIPE REDUCING BRANCH T



Available in PVDF upon demand

CAT. NO.	R Thread BSPT	R1 Thread BSPT	SW mm	Color
12017104028	1/4"	1/8"	14	
12017106048	3/8"	1/4"	14	
12017108068	1/2"	3/8"	14	
12017102048	1/8"	1/4"	14	
12017104068	1/4"	3/8"	17	
12017106088	3/8"	1/2"	17	
CAT. NO.	R Thread NPT	R1 Thread NPT	SW mm	Color
12027104023	1/4"	1/8"	12	

→ PIPE REDUCING RUN T



Available in PVDF upon demand

CAT. NO.	R Thread BSPT	R1 Thread BSPT	SW mm	Color
12017204028	1/4"	1/8"	12	
12017206048	3/8"	1/4"	15	
12017208068	1/2"	3/8"	17	
12017202048	1/8"	1/4"	12	
12017204068	1/4"	3/8"	15	
12017206088	3/8"	1/2"	17	
CAT. NO.	R Thread NPT	R1 Thread NPT	SW mm	Color
12027204023	1/4"	1/8"	12	

→ OD-Outer diameter → SW-Standard Wrench
→ ID-Inner diameter → R-Radius



QUICK CONNECTOR

Material: Acetal resin, stainless steel spring. Sealed by NBR "O" ring.

Colour: Black and Red.

 Working pressure: Up to 14 BAR (200 psi).

 Temperature: -20°C +110°C (subject to application).

This small quick connector has easily movable sleeve that locks the plug in place. When the plug is disconnected the socket acts as shut off valve.
Uses: In air and water lines.

→ QUICK RELEASE SOCKET



CAT. NO.	Thread BSPT	SW mm
* 22080004000	1/4"	19
** 22081104002	1/4"	19

* The body is made of Nylon.
** With viton seal.

→ PLUG - EXTERNAL THREAD

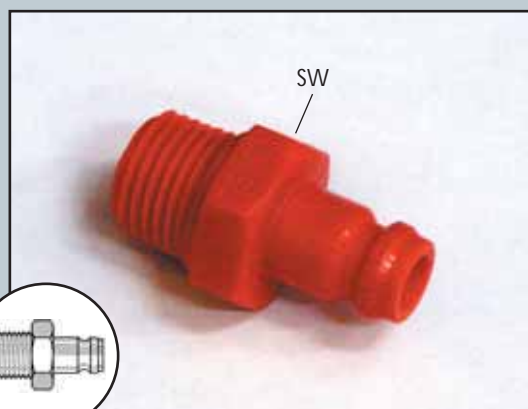

CAT. NO.	Thread BSPT	SW mm
12081404006	1/4"	17

→ PLUG - INTERNAL THREAD

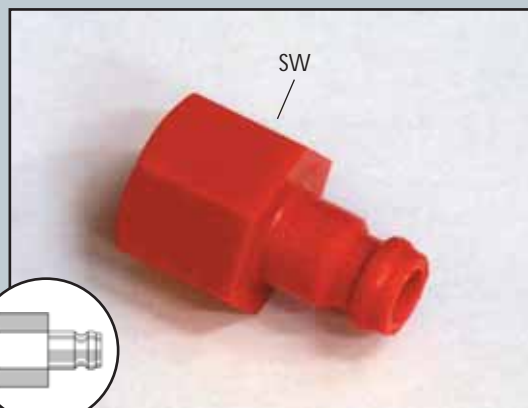

CAT. NO.	Thread BSPT	SW mm
12081504006	1/4"	17

→ OD-Outer diameter → SW-Standard Wrench
→ ID-Inner diameter → R-Radius

→ PLUG - HOSE CONNECTOR

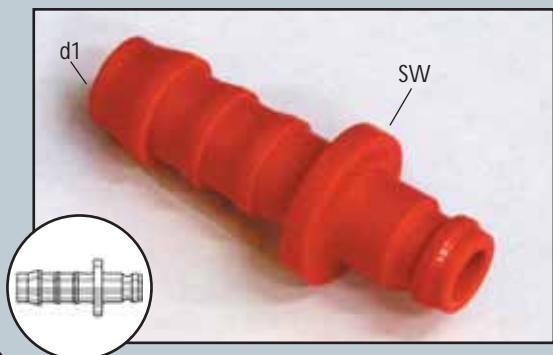

CAT. NO.	d-Tube I.D	SW mm
12081645006	5 mm	17
12081646006	6 mm	17
12081648006	8 mm	17
12081650006	10 mm	17
12081652006	12 mm	17

→ VALVE 1 / 4 "

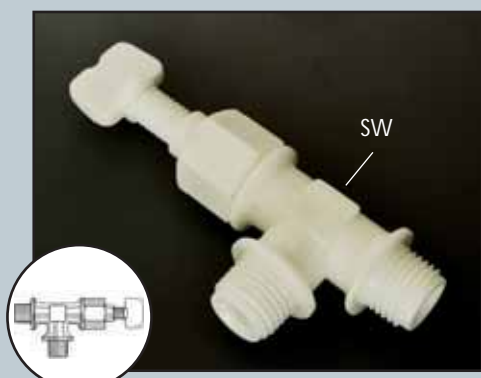

CAT. NO.	Thread BSPT
22272904011	1/4"
22272904012	1/4"
22272904017	1/4"

Material: Acetal.
This needle valve is used for controlling small quantities of water in indoor applications.

BALL VALVE 1/4" BSP
MALE X FEMALE



CAT. NO. 17010000001
Material: Acetal
SW: 21 mm
I.D: 5.5 mm
Working Pressure: 8 bar

→ SILENCER WITH RESTRICTOR VALVE
FOR PNEUMATIC VALVES

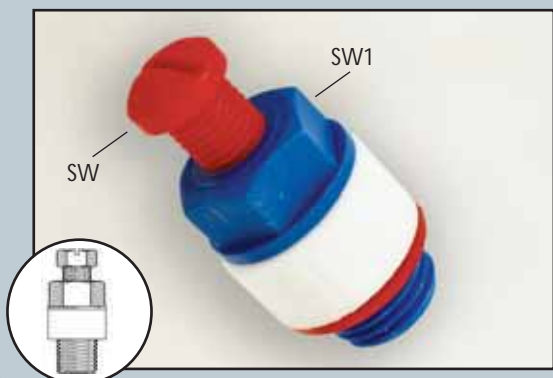

CAT. NO.	Thread BSPT	SW mm	SW1 mm
PLASTIC SCREW 22276004000 22276008000	1/4"	15	13
	1/2"	25	18
BRASS SCREW 22276004010 22276008010	1/4"	15	13
	1/2"	25	18

This combined silencer and restrictor valve unit provides cylinder speed adjustment and noise reduction. Silencer is generally inserted in air outlet of cylinder control valve.

→ VALVE RELEASE / DRAIN VALVE



CAT. NO.	Thread BSPT
22273008002	1/2"
22273108002	1/2"

Valve release
Valve installed vertically upwards on the highest point. Functions as antisiphon valve (CAT. No. 22273008002).

Drain Valve with stainless spring. Valve installed at pipe end.
For automatic drainage of condensed water in compressed-air lines, after shut-off of compressed-air supply. (CAT. No. 22273108002)

→ LDPE

→ LDPE CONTROL TUBES



CAT. NO.	O.D	I.D	Min bend radius	Roll Length
14030004501	1/4"	0.170"	1"	500 m
14030004506	1/4"	0.170"	1"	500 m
14030004507	1/4"	0.170"	1"	500 m
14030004508	1/4"	0.170"	1"	500 m
14030004509	1/4"	0.170"	1"	500 m
1403004601X	6 mm	4 mm	1"	100 m
1403004620X	6 mm	4 mm	1"	200 m
1403004650X	6 mm	4 mm	1"	500 m
1403004810X	8 mm	5.3 mm	11/2"	100 m
1403004820X	8 mm	5.3 mm	11/2"	200 m
1403004850X	8 mm	5.3 mm	11/2"	500 m

Available to order between 1 to 4 stripes (in the same color)
Standard 2 stripes

Standard packaging for all tubes →



Drum packaging available for 500 m rolls →



WRAS APPROVED PRODUCT

→ LDPE TUBES



CAT. NO.	O.D	I.D	Min bend radius	Roll Length
1403000310X	3/16"	0.117"	1/2"	100 m
1403000410X	1/4"	0.170"	1"	100 m
1403000510X	5/16"	0.212"	1 1/2"	100 m
1403000610X	3/8"	0.256"	2"	100 m
1403000810X	1/2"	0.381"	3"	100 m
1403004410X	4 mm	2.2 mm	12 mm	100 m
1403004610X	6 mm	4 mm	25 mm	100 m
1403000510X	8 mm	5.3 mm	35 mm	100 m
1403005010X	10 mm	7 mm	50 mm	100 m
1403005210X	12 mm	9 mm	75 mm	100 m

Standard packaging for all tubes →



WRAS APPROVED PRODUCT

Recommended Work Pressure For All PE Tubes At 20^o is 10 Bar (147 PSI): Class (rank) 10

Recommended nominal working pressure for LDPE

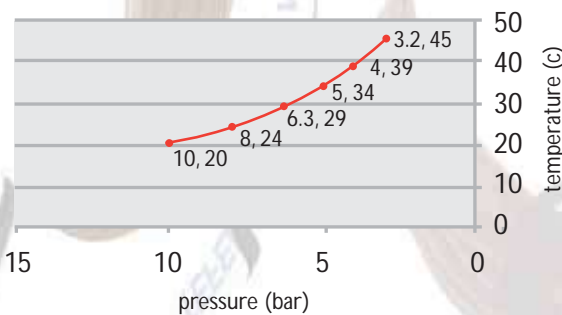

COLOR CODING:

LDPE control tubes: X stands for the color of the added stripes (basic color of the tube is black).

LDPE tubes: X stands for the color of the tube.

- 1 White
- 2 Black
- 6 Red
- 7 Green
- 8 Blue
- 9 Yellow

WRAS APPROVED PRODUCT

Certification is only for blue & black tubes

→ HDPE

→ HDPE PN-16		CAT. NO.	O.D	W.T.	Nominal Pressure Bar (PSI)	Min Band Radius	Packing
		1402004610X	6.00 mm	0.8 mm	16 (235.2)	30 mm	100 M
		1402004620X	6.00 mm	0.8 mm	16 (235.2)	30 mm	200 M
		1402004650X	6.00 mm	0.8 mm	16 (235.2)	30 mm	500 M
		1402000410X	1/4" (6.35 mm)	1/32" (0.8 mm)	16 (235.2)	1.25"	100 M
		1402000420X	1/4" (6.35 mm)	1/32" (0.8 mm)	16 (235.2)	1.25"	200 M
		1402000450X	1/4" (6.35 mm)	1/32" (0.8 mm)	16 (235.2)	1.25"	500 M
		1402004810X	8.00 mm	1.00 mm	16 (235.2)	40 mm	100 M
		1402004820X	8.00 mm	1.00 mm	16 (235.2)	40 mm	200 M
		1402004850X	8.00 mm	1.00 mm	16 (235.2)	40 mm	500 M
		1402000510X	5/16" (8.00 mm)	0.039" (1.00 mm)	16 (235.2)	1.6"	100 M
		1402000520X	5/16" (8.00 mm)	0.039" (1.00 mm)	16 (235.2)	1.6"	200 M
		1402000550X	5/16" (8.00 mm)	0.039" (1.00 mm)	16 (235.2)	1.6"	500 M





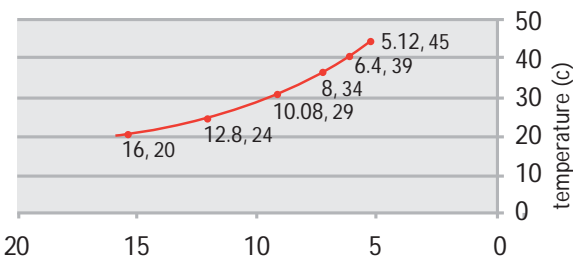

The recommended maximum working pressure at 20⁰ is 16 Bar (235.2 PSI): Class (rank) 16

Recommended nominal working pressure for HDPE

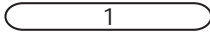

HDPE COLOR CODING:

HDPE tubes: X stands for the color of the tube.



-  1 White
-  2 Black
-  6 Red
-  7 Green
-  8 Blue
-  9 Yellow

→ HDPE PN-24		CAT. NO.	O.D	W.T.	Nominal Pressure Bar (PSI)	Min Band Radius	Packing
		14010046102	6.00 mm	0.8 mm	24 (353)	30 mm	100 M
		14010046202	6.00 mm	0.8 mm	24 (353)	30 mm	200 M
		14010046502	6.00 mm	0.8 mm	24 (353)	30 mm	500 M
		14010004102	1/4" (6.35 mm)	0.035" (0.9 mm)	24 (353)	1.25"	100 M
		14010004202	1/4" (6.35 mm)	0.035" (0.9 mm)	24 (353)	1.25"	200 M
		14010004502	1/4" (6.35 mm)	0.035" (0.9 mm)	24 (353)	1.25"	500 M
		14010048102	8.00 mm	1.00 mm	24 (353)	40 mm	100 M
		14010048202	8.00 mm	1.00 mm	24 (353)	40 mm	200 M
		14010048502	8.00 mm	1.00 mm	24 (353)	40 mm	500 M
		14010005102	5/16" (8.00 mm)	0.039" (1.00 mm)	24 (353)	1.6"	100 M
		14010005202	5/16" (8.00 mm)	0.039" (1.00 mm)	24 (353)	1.6"	200 M
		14010005502	5/16" (8.00 mm)	0.039" (1.00 mm)	24 (353)	1.6"	500 M

The recommended maximum working pressure at 20⁰ is 24 Bar (353 PSI): Class (rank) 24

→ PVC

→ PLASTICIZED PVC TUBES		CAT. NO.	O.D	I.D	Roll Length
		1407000510X	5 mm	3 mm	100 m
		1407000520X	5 mm	3 mm	200 m
		1407000525X	5 mm	3 mm	250 m
		1407000550X	5 mm	3 mm	500 m
		1407000505X	5 mm	3 mm	50 m
		1407006510X	6.5 mm	4 mm	100 m
		1407006520X	6.5 mm	4 mm	200 m
		1407000710X	7 mm	4 mm	100 m
		1407000720X	7 mm	4 mm	200 m
		1407000725X	7 mm	4 mm	250 m
		1407000750X	7 mm	4 mm	500 m
		1407464905X	9 mm	6 mm	50 m
		1407001020X	10 mm	7 mm	100 m
		1407001220X	12 mm	7 mm	100 m
		1407001310X	13 mm	9 mm	100 m
		1407001610X	16 mm	11 mm	100 m

Standard PVC tubes are black 
 Also available in transparent 
 or brown 

→ O.D-Outer diameter → SW-Standard Wrench
 → I.D-Inner diameter → R-Radius

→ **Air Blow Gun**
with a general purpose nozzle



1/4" female cat No. 22200004022
11/16" male cat No. 22200011052

→ **Air Blow Gun**
with an osha regulation safety nozzle



1/4" female cat No. 22200004012
11/16" male cat No. 22200011082

→ **Air Blow Gun**
with an air screen nozzle to deflect flying chips away from operator



1/4" female cat No. 22200004032
11/16" male cat No. 22200011062

→ **Air Blow Gun Mark II**



cat No. 22240000060 with 6 mm nozzle
cat No. 22240000080 with 8 mm nozzle
available only with minimum order

→ **Air Blow Gun**
with a restriction nozzle to regulate output air volume



1/4" female cat No. 22200004042
11/16" male cat No. 22200011072

→ **Air Blow Gun Mark III**



cat No. 22230000000

→ OD-Outer diameter → SW-Standard Wrench
→ ID-Inner diameter → R-Radius

→ Mini Air Blow Gun



cat No. 22190000012 with on osha regulation safety nozzle
cat No. 22190000002

→ 8 mm Nylon Retractable Coil



cat No. 24050505058-5 feet
cat No. 24050505108-10 feet
cat No. 24050505158-15 feet

→ Spray Gun



1/4" female cat No. 22210004002
11/16" male cat No. 22210011003

→ Short Spray Gun



1/4" female cat No. 22210004004 IODINE

→ Fine Spray

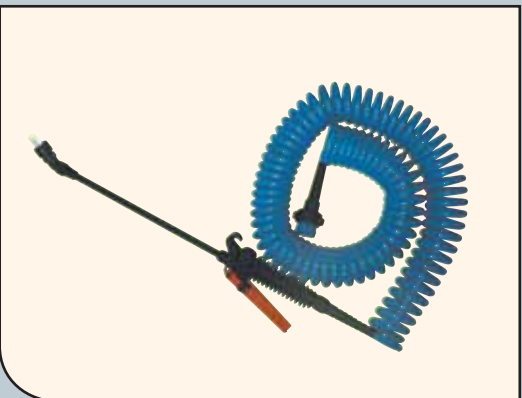

Female end connector
3/4" cat No. 22210512488
1/2" cat No. 22210508488



→ OD-Outer diameter → SW-Standard Wrench
→ ID-Inner diameter → R-Radius

→ FAN SPRAY NOZZLES



CAT. NO.	Marking	Angle	Color	Lit/Min Bar 2	Lit/Min Bar 3	Lit/Min Bar 4	Lit/Min Bar 6
12210110057	110 005	110°	Green	0.296	0.362	0.417	0.513
12210110209	110 02	110°	Yellow	1.20	1.45	1.70	2.00
12210110255	110 025	110°	White	0.623	0.780	0.899	1.106
12210110308	110 03	110°	Blue	1.167	1.432	1.649	2.039
12210110406	110 04	110°	Red	1.434	1.760	2.032	2.501
12210110503	110 05	110°	Dark Red	1.627	2.027	2.350	2.893
12210165051	65 005	65°	White	0.38	0.47	0.53	0.66
12210165052	65 005	65°	Black	0.38	0.47	0.53	0.66

→ CONICAL SPRAY NOZZLE



CAT. NO.	Marking	Angle	Color	Lit/Min Bar 2	Lit/Min Bar 3	Lit/Min Bar 4	Lit/Min Bar 6
22210011055	1 105	105°	White	0.058	0.068	0.078	0.098
22210011057	1 105	105°	Green	0.058	0.068	0.078	0.098
22210016502	1 65	65°	Grey	0.061	0.074	0.084	0.098
22210018001	1 80	80°	White	0.063	0.078	0.092	0.117
22210018002	1 80	80°	Black	0.063	0.078	0.092	0.117
22210018011	1 80F	80°	White	0.035	0.042	0.049	0.059
22210018012	1 80F	80°	Black	0.035	0.042	0.049	0.059
22210028006	3 80	80°	Red	0.350	0.430	0.520	0.630

→ CONICAL SPRAY NOZZLE
1/8" NPT



CAT. NO.	Marking	Angle	Color	Lit/Min Bar 2	Lit/Min Bar 3	Lit/Min Bar 4	Lit/Min Bar 6
22210211055	21 105	105°	White	0.063	0.075	0.086	0.108
22210218008	21 80	80°	Blue	0.060	0.070	0.080	0.093
22210078001	07 80	80°	White	0.043	0.053	0.060	0.069
22210078002	07 80	80°	Black	0.043	0.053	0.060	0.069
22210078003	07 80	80°	Grey	0.043	0.053	0.060	0.069
22210221202	22 120	120°	Black	0.108	0.132	0.152	0.190
22210078006	07 80F	80°	Red	0.038	0.047	0.054	0.064
22210078011	07 80F	80°	White	0.038	0.047	0.054	0.064
22210078012	07 80F	80°	Black	0.038	0.047	0.054	0.064

→ NON DROP CONICAL
SPRAY NOZZLES 1/8" NPT



CAT. NO.	Marking	Angle	Color	Lit/Min Bar 3	Lit/Min Bar 4	Lit/Min Bar 6
22211211052	21 105	105°	Black	0.072	0.084	0.106
22211211055	21 105	105°	White	0.072	0.084	0.106
22211218008	21 80	80°	Blue	0.092	0.074	0.06
22211078001	07 80	80°	White	0.046	0.053	0.069
22211078002	07 80	80°	Black	0.046	0.053	0.069
22211078003	07 80	80°	Grey	0.046	0.053	0.069
22211221202	22 120	120°	Black	0.120	0.142	0.182
22211078006	07 80F	80°	Red	0.040	0.048	0.062
22211078011	07 80F	80°	White	0.040	0.048	0.062
22211078012	07 80F	80°	Black	0.040	0.048	0.062

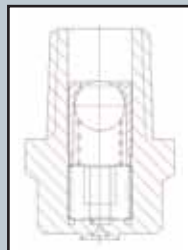

→ OD-Outer diameter → SW-Standard Wrench
→ ID-Inner diameter → R-Radius

→ CONICAL SPRAY NOZZLE
1/8" NPT WITH FILTER

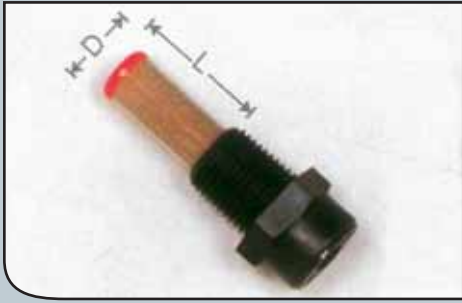

CAT. NO.	Marking	Angle	Color	Lit/Min Bar 2	Lit/Min Bar 3	Lit/Min Bar 4	Lit/Min Bar 6	D	L
22219211055	21 105	105°	White	0.060	0.070	0.080	0.093	7	15
22219218008	21 80	80°	Blue	0.060	0.070	0.080	0.093	7	15
22219078001	04 80	80°	White	0.041	0.050	0.057	0.066	7	15
22219078002	04 80	80°	Black	0.041	0.050	0.057	0.066	7	15
22219078002	07 80	80°	Grey	0.043	0.053	0.060	0.069	7	15
22219221202	22 120	120°	Black	0.103	0.124	0.149	0.171	7	15
22219078006	07 80F	80°	Red	0.040	0.046	0.053	0.061	7	15

The filter is available also in 8 mm length (L)

→ ADJUSTABLE NOZZLE



CAT. NO. 22214200001

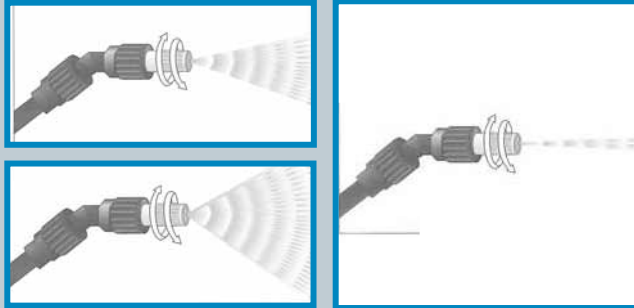

→ NOZZLE FILTERS



CAT. NO.	Mesh	Dmm	SW mm
22212791150	50	10.5	21
22212791100	100	10.5	21
22212791220	200	10.5	21

→ NON DROP NOZZLE FILTERS

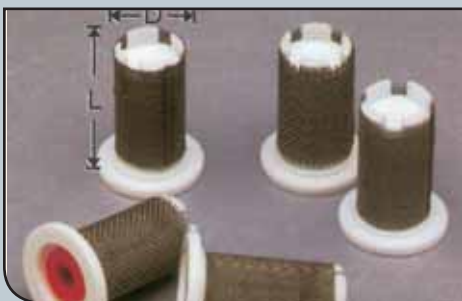

CAT. NO.	Mesh	Dmm	SW mm
22212791050	50	10.5	21
22212791000	100	10.5	21
22212791200	200	10.5	21

→ NUT 11/16" FOR NOZZLE

CAT. NO.	R1
32272900082	11/16" NC



Also available in white and green

→ 1/4" FEMALE STRAIGHT NOZZLE HOLDER

CAT. NO.	R1	R2
32210300042	11/16" NC	1/4" NPT



Also available in white

→ 1/4" MALE STRAIGHT NOZZLE HOLDER

CAT. NO.	R1	R2
32212200042	11/16" NC	1/4" NPT



Also available in white

→ 1/4" FEMALE 135° NOZZLE HOLDER

CAT. NO.	R1	R2
32210000040	11/16" NC	1/4" NPT



→ OD-Outer diameter → SW-Standard Wrench
→ ID-Inner diameter → R-Radius

→ PUSH-IN FITTING ADAPTOR FOR 1/8" NOZZLES



CAT. NO.	STEM D	INNER THREAD
22211502061	3/8"	1/8" NPT
22211502062	3/8"	1/8" NPT

→ MISTING UNIT MARK 1

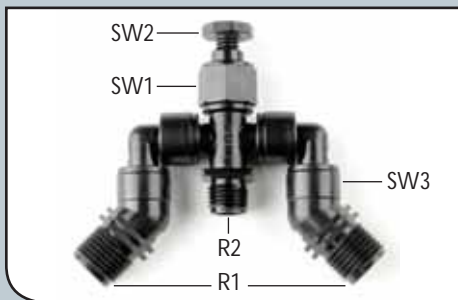

CAT. NO.	R1	R2	SW1	SW2	SW 3	COLOR
22272900101	11/16" NC	1/4" NPT	17.5	16	17.5	
22272900102	11/16" NC	1/4" NPT	17.5	16	17.5	
22272900107	11/16" NC	1/4" NPT	17.5	16	17.5	

→ FINGER FILTER



CAT. NO.	MESH	DIAMETER	LENGTH	I.D.	O.D.
22212002028	100	7 mm	28 mm	1/8" BSPT	1/8" BSPT

→ FINGER FILTER



CAT. NO.	MESH	DIAMETER	LENGTH	I.D.	O.D.
22212791002	100	3/8"	1 7/8"	1/8" Npt	1/4" Npt

→ → → P R O P E R T I E S

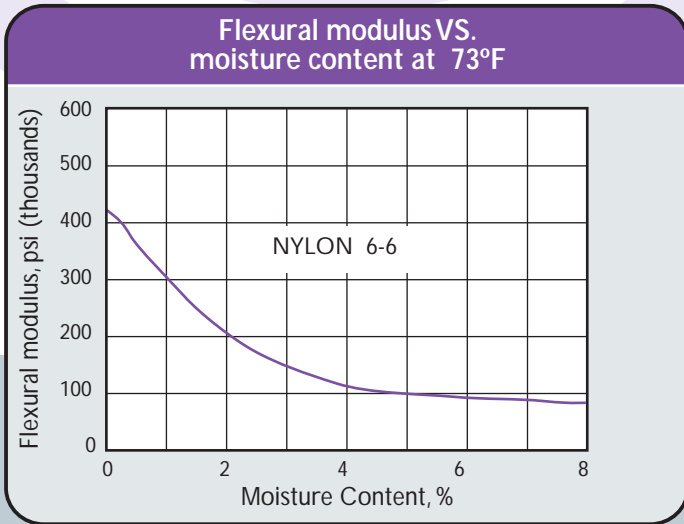
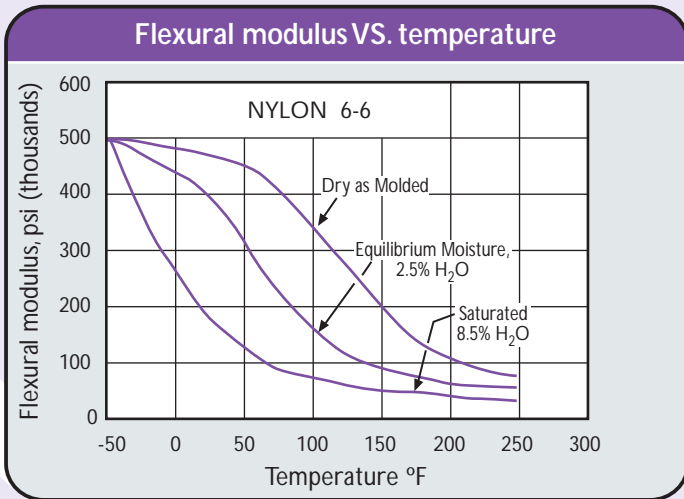
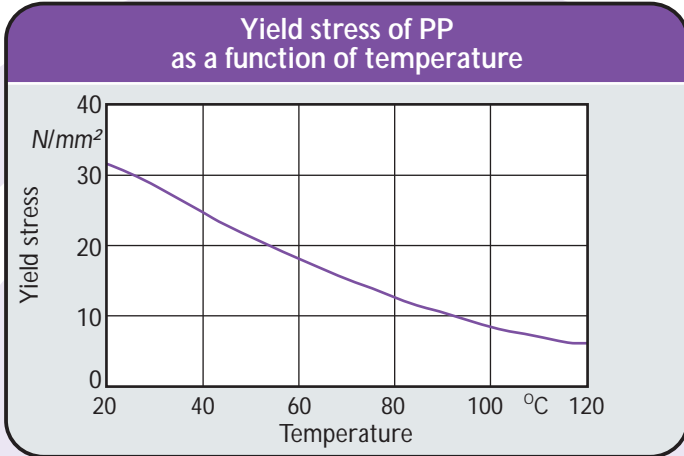

Please Note:

Tefen, is constantly seeking ways to improve the specifications of its products. Whilst every effort is made to produce up-to-date literature, this brochure should not be regarded as an infallible guide to current specifications, nor does it constitute an offer for the sale of any particular product. Prospective purchasers of the products from Tefen should satisfy themselves at the time they place the order as to the suitability of the products for the particular application. We have the right to alter specification without prior notice.



TEFEN Advanced Plastic Solutions

Owned by Kibbutz Nahsholim in Israel, Tefen Advanced Plastic Solutions has nearly 40 years experience in producing advanced plastics products. These comprise two main groups: Fittings for the pneumatic, automation and irrigation industries; and MixRite Proportioning Dosing Injectors for industrial, agricultural and livestock applications. We also manufacture a range of products for horticulture.

Our Research & Development department follows the latest innovations in plastics technology, ensuring that customers benefit from quick and sound solutions. In recent years the focus has been on proportioning dosing: developing the MixRite range of injectors to inject functional additives into liquid medium system using a uniform repeating method.

These innovations, bringing significant advances to a wide range of industries, have helped us to export 70% of our production to customers located all over the world. They rely on the Tefen name for advanced and highly reliable products, backed by unmatched customer service. The Tefen plant is certified for ISO 9001:2000 and we meet all international standards.

34-0166.6.09

ISRAEL LEVY ADV.



TEFEN Manufacture & Marketing Plastic Products 1990 Ltd.
Nahsholim 30815 Israel, Tel 972-4-6395550, Ex. Dep. 972-4-6395554, Fax. 972-4-6390813
E-mail: export@tefenplastic.com • Web Site: www.tefenplastic.com

